



Imagine the possibilities...

3075 Herold Drive Sudbury, Ontario P3E 6K9

Phone: 705-522-8220 • Toll Free: 1-800-461-4888 • Fax: 705-522-2732

Hardscape Resource Guide

www.brownsconcrete.com

Volume 117



CONCRETE
MASONRY &
HARDSCAPES
ASSOCIATION



CANADIAN
HOME BUILDERS'
ASSOCIATION

HORTICULTURAL TRADES ASSOCIATION
landscapeontario.com



Canadian Concrete Masonry
Producers Association
Region 6 of the National
Concrete Masonry
Association



RESOURCE GUIDE CONTENTS

Outcropping Block Details & Outcropping Retaining Wall	1
Freestanding Block Details & Typical Freestanding Wall	2
Outcropping Installation: Retaining & Freestanding Walls	3
Outcropping Installation: Curves	4
Outcropping Installation: Patterns	5
Rosetta Grand Ledge	6
Random Steps & Dimensional Steps	7
Step Fillers	8
Step Installation	9
Rockton Wall & Corners	10
Rockton Wall & Rockton Curved Walls	11
Northface & Superior Steppers	12
Belvedere Block & Belvedere Coping Details	13
Belvedere Retaining & Freestanding Wall Installation	14
Belvedere Curves Installation	15
Belvedere Pillars Installation	16
Dimensional Wall, Coping & Caps	17
Wedgestone	18
Parkwall	19
Parkwall Steps Installation	20
Appian 70 & Appian 50	21
Appian XL & Aztec XL	22
Amberley	23
Aztec 70 & Aztec 50	24
Athenian & Avennio	25
Nordic	26
DC 80	27
Aquapave	28
Venetian Random & Venetian Circle	29
Venetian Circle (cont'd) & Signature Curb Collection	30
Belgium	31
Grand Flagstone Block Details	32
Grand Flagstone Installation 1	33
Grand Flagstone Installation 2	34
Flagstone & Paver Installation Guide	35
Belvedere, Dimensional, Rockton Fire Pit Kits	36
Oxford Fire Pit Kit & Antico Stacker	37
General Paver Installation	38
Retaining Wall Installation	39
Project Planner Grid	40-41

OUTCROPPING BLOCK DETAILS



OUTCROPPING PALLET A	
Pallet weight	± 4000 lbs. (±1,814 kg)
Coverage	18 ft. ²

Stone & Bundling	Unit Dimensions (inches)		Units Per Bundle	Weight±/ Stone	
	L	W		lbs	kg
	42	12	1	749	340
	48	12	1	893	406
	60	12	1	1,103	501
	66	12	1	1,140	518



OUTCROPPING PALLET B	
Pallet weight	± 4000 lbs. (±1,814 kg)
Coverage	18 ft. ²

Stone & Bundling	Unit Dimensions (inches)		Units Per Bundle	Weight±/ Stone	
	L	W		lbs	kg
	24	6	1	250	113
	36	6	1	324	147
	36	12	1	620	281
	48	6	1	442	201
	54	12	1	950	431
	72	12	1	1,294	587



OUTCROPPING PALLET C	
Pallet weight	± 4000 lbs. (±1,814 kg)
Coverage	18 ft. ²

Stone & Bundling	Unit Dimensions (inches)		Units Per Bundle	Weight±/ Stone	
	L	W		lbs	kg
	24	6	1	250	113
	36	6	1	324	147
	60	18	1	1,633	741
	48	24	1	1,801	817

OUTCROPPING RETAINING WALL TYPICAL GRAVITY WALL SECTION

This page shows typical construction details for Gravity walls. These drawings are representative of the major components required in wall construction. Specific details, including geotextile reinforcement layers, drainage details, soil requirements, etc., shall be per professionally engineered design for wall.

For more cross-section and design options, please visit www.rosettahardscapes.com and click on "engineering."

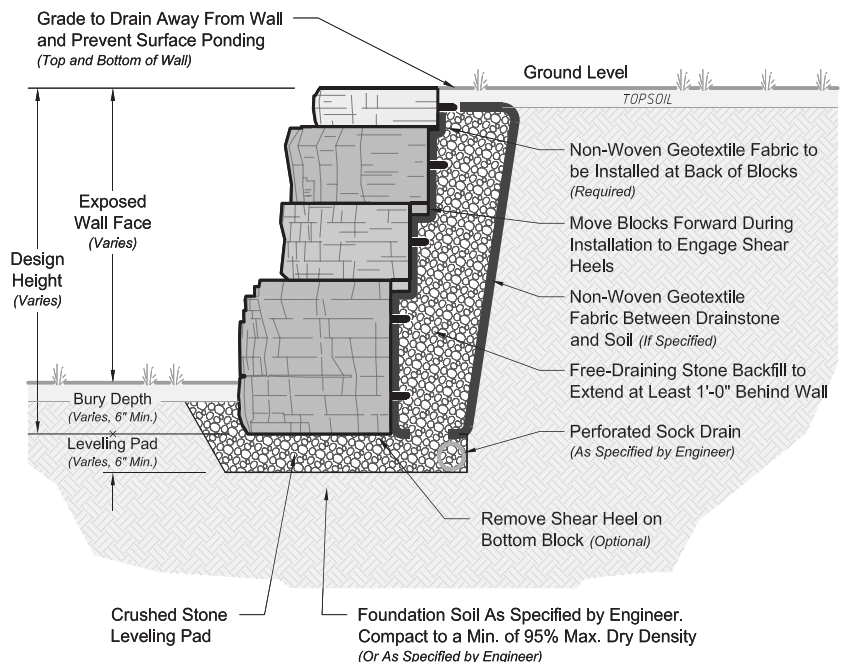



Actual weight and colour may vary.

FREESTANDING BLOCK DETAILS

OUTCROPPING PALLET G

Limited Inventory Available





Stone & Bundling	Unit Dimensions (inches)			Units per Bundle	Weight [±] / Stone	
	L	W	H		lbs	kg
	72	30	12	1	1,972	895
	36	30	12	1	986	448
	36	30	6	1	492	200

OUTCROPPING PALLET G

Pallet weight	± 3,450 lbs. (± 1,552.5 kg)	Coverage	10.5 ft. ²
---------------	-----------------------------	----------	-----------------------

OUTCROPPING PALLET H



Stone & Bundling	Unit Dimensions (inches)			Units per Bundle	Weight [±] / Stone	
	L	W	H		lbs	kg
	60	30	12	1	1,431	650
	48	30	12	1	1,146	520
	48	30	6	1	573	260

OUTCROPPING PALLET H

Pallet weight	± 3,150 lbs. (± 1,417.5 kg)	Coverage	11 ft. ²
---------------	-----------------------------	----------	---------------------

TYPICAL FREESTANDING WALL

This page shows typical construction details for Outcropping Freestanding walls. These drawings are representative of major components required in wall construction. Specific details including drainage details, soil requirements, etc. must be based upon professionally-engineered per-project.

Freestanding Wall Blocks

NOTE: Block size and placement shown are for reference only. Individual Brown's blocks will vary with installation pattern. Actual design must be performed by a licensed engineer.

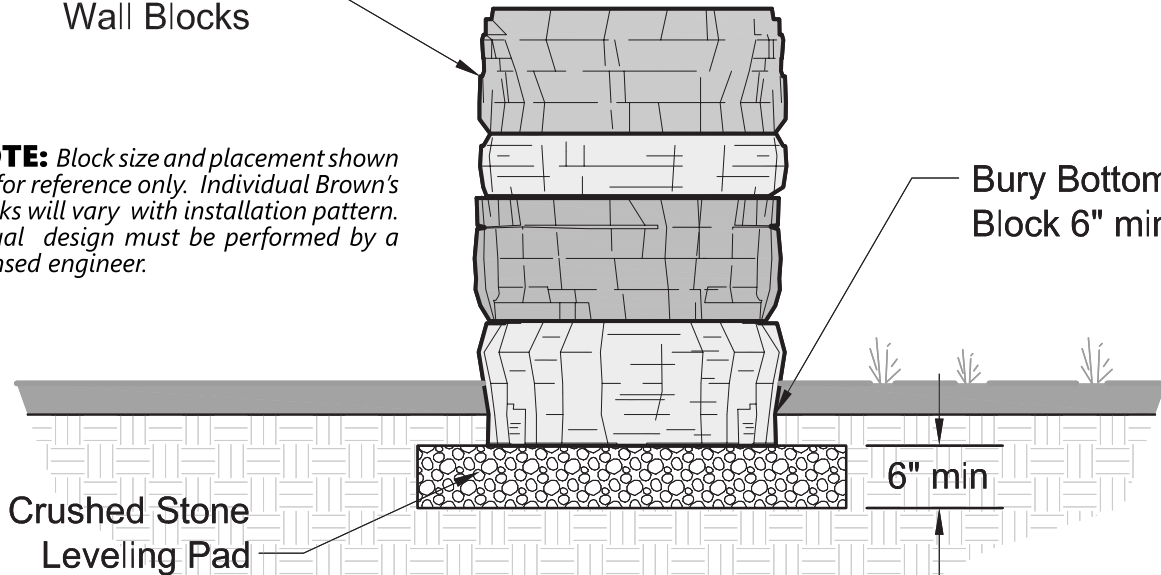

Bury Bottom Block 6" min

6" min

Crushed Stone Leveling Pad

OUTCROPPING INSTALLATION: RETAINING & FREESTANDING WALLS

OUTCROPPING NOTES FOR INSTALLATIONS REQUIRING GEOGRID

Please visit www.rosettahardscapes.com for detailed cross-sections of geogrid reinforced Outcropping walls. For Brown's Outcropping installations, do not overlap geogrid over top of blocks. Instead: run the geogrid directly up to the back of the blocks.

In addition to this reinforcement, a Paraweb strap must be installed through each lifting hook in the back of the Outcropping blocks. Please see standard details for Reinforced Outcropping Walls for further information.

Place and compact drainstone and reinforced fill following the procedure used to set the bottom and upper courses of blocks. It is important to place and compact stone and reinforced fill starting at the back of the retaining blocks and extending into the reinforced soil zone. This will help eliminate "bunching" of the geogrid reinforcement.

Reinforced zone fill material is typically a sand or gravel with less than 5% "fines" (material passing the No. 200 sieve). This material is usually classified as a GW, GP, SW, or SP. It is very important that you only use the fill material specified in your project design drawings and specifications.

Place retained soil immediately between the reinforced soil zone and the back of the excavation. Material should be placed in loose lifts of 8" (200 mm) maximum and compacted to 95% maximum density as determined by a Standard Proctor test (ASTM D698). Bring the reinforced and retained soil up to grade at the same time. At no time should the elevation of the reinforced soil be more than 1 block higher than the retained soil. Tracked construction equipment should not be used directly on the geogrid. A minimum of 6" (150 mm) of fill is required between tracked equipment and geogrid to prevent damage to the grid. Rubber-tired equipment may pass over the geogrid when traveling at low speeds of 5 mph (8 km/h) or less. Avoid any sudden stopping or turning of construction equipment in the reinforced fill zone to prevent moving or damaging the geogrid layers. Follow geogrid manufacturer's requirements, including requirements for vertical separation and overlap of geogrid.

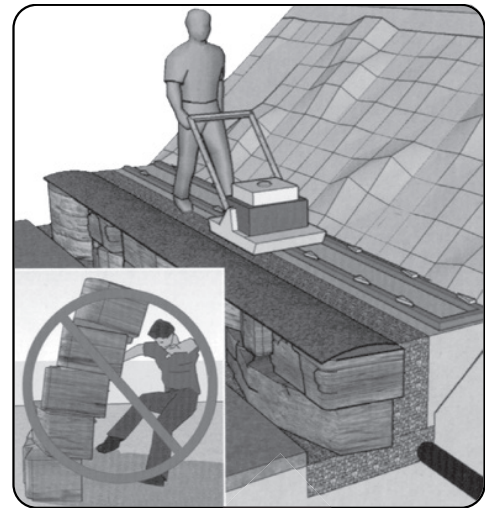

For All Installations never stack blocks more than one course above grade of backfill.

OUTCROPPING LAYOUT NOTES

One of the unique features of the Brown's Outcropping system is multiple block heights. To provide a uniform wall batter with multiple height blocks, the setback of the blocks varies proportionally with the block height. This setback in blocks is achieved with shear heels which are cast into the Brown's blocks. For a 6" high block, the shear heels are 3" deep (1x3"). For a 24" high block, the shear heels are 6" deep (2x3").

To ensure proper wall alignment and to account for the multiple height blocks and varying setbacks, the bottom row of blocks must be adjusted based on their height.

Set up a traditional string line for the back of the wall, then offset the blocks as per the following figure.

OUTCROPPING LIFTING DEVICE

Note: the outcropping lifting device is a required tool for any proper installation using the Outcropping System

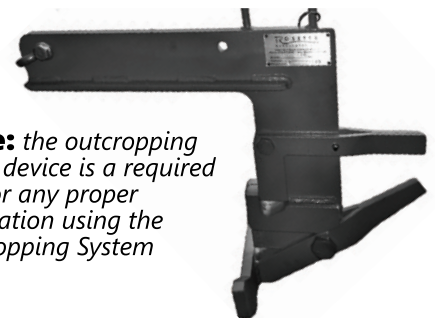

BACK OF WALL STRING LINE(TOP VIEW)

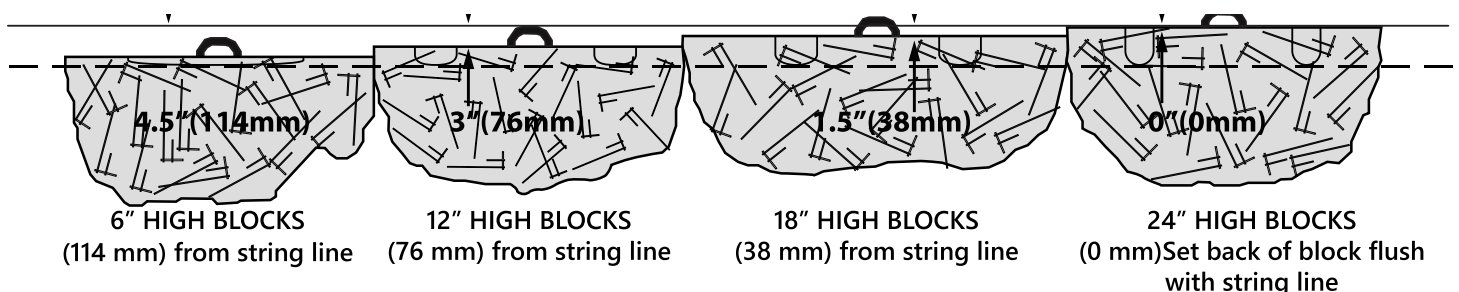

OUTCROPPING INSTALLATION: CURVES

Brown's Blocks have shear heels to help with wall integrity and provide a setback from lower blocks in the wall. This causes the wall to batter back. The batter is important to the engineering design of the wall, and it must be accounted for during construction of a curved wall section.

OUTSIDE (CONVEX) CURVE

If you are constructing an outside (convex) curve, the wall batter will cause the blocks higher in the wall to have a shorter radius around the curve than lower blocks. This will cause the higher blocks to "grow" in the wall layout pattern. (This is similar in concept to the inside lane of a race track that is shorter than the outside lane). The result is a potential overlap between some of the blocks in the wall. The best way to deal with this overlap is to saw cut the end of the smaller block, which allows the other blocks to fit tightly together. This will properly engage all of the shear heels. Saw cutting here is typically made on an angle to match the taper on the block you are abutting.

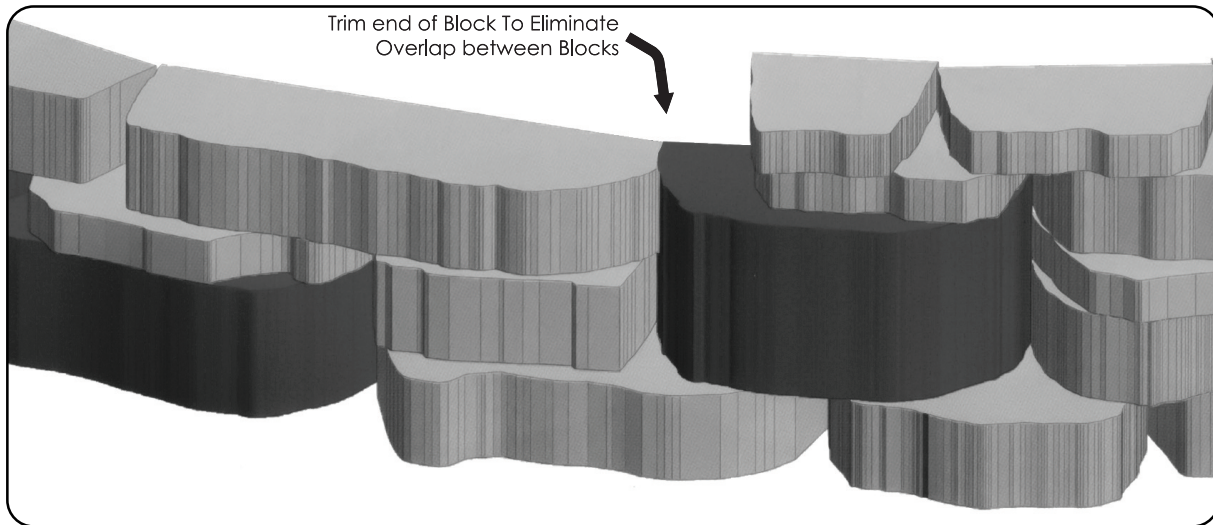

INSIDE (CONCAVE) CURVE

If you are constructing an inside (concave) curve, the wall batter will cause the block higher in the wall to have a longer radius around the curve than the lower blocks. The important step when constructing an inside curve is to keep all blocks fitted tightly together. In most cases, the blocks will touch somewhere along the sides of the blocks, not at the back of the blocks. If needed, you can trim the ends off of some blocks to prevent gaps from opening up between blocks. When constructing a curve with a short radius, voids may form at the back of the wall where blocks meet. If this happens, simply fill the void areas with filter fabric and drainstone.

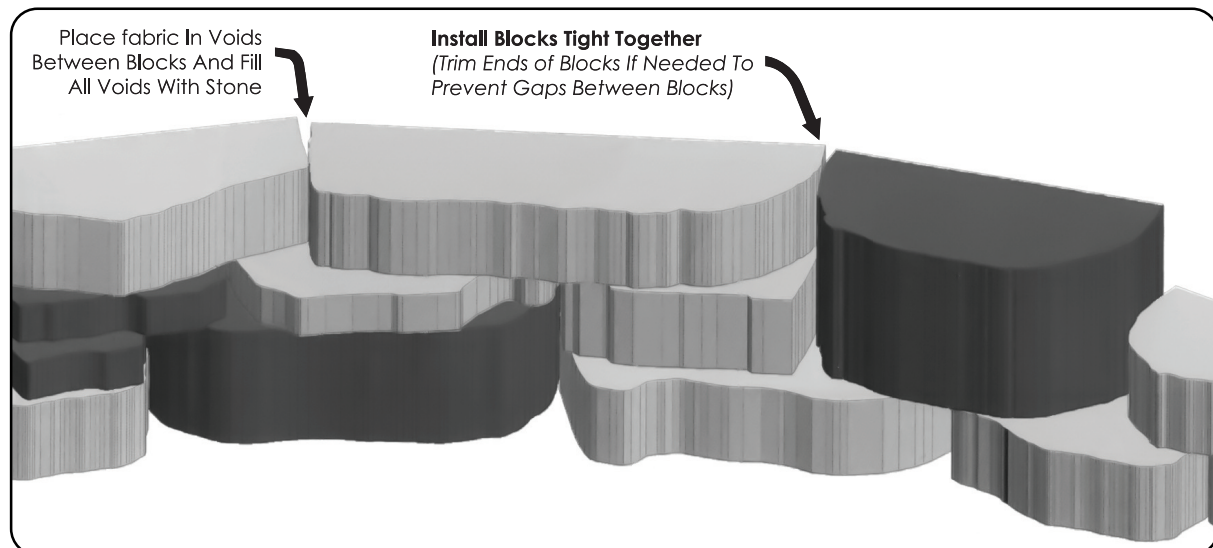

OUTCROPPING INSTALLATION: PATTERNS

Please note that the length dimensions shown for Brown's blocks are rounded for reference. The actual length of the constructed wall will vary slightly from the pattern dimensions shown.

Each pattern is made up of (2) A Pallets, (2) B Pallets, and (1) C Pallet.

2' X 45' WALL SECTION SHOWN:

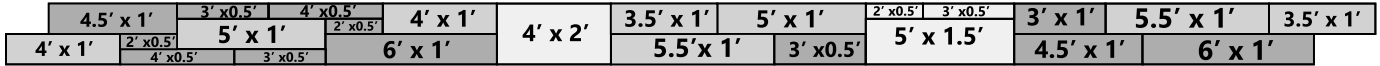

3' X 30' WALL SECTION SHOWN:

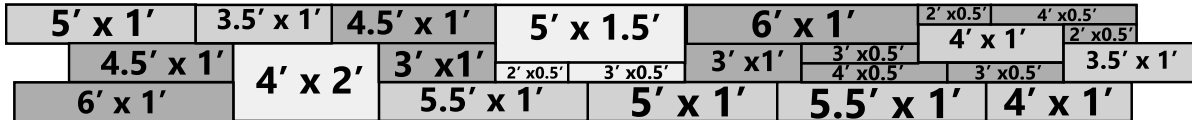

4' X 22.5' WALL SECTION SHOWN:

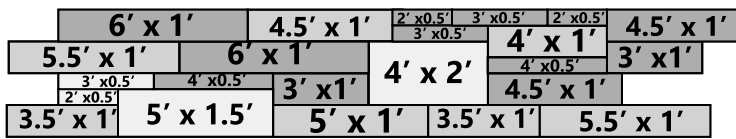

5' X 18' WALL SECTION SHOWN:

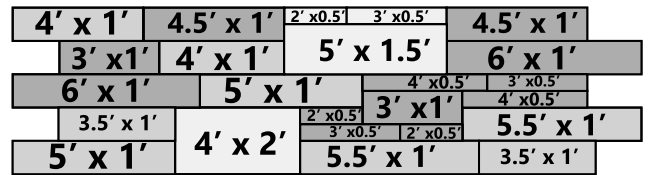

OUTCROPPING CORNER PATTERNS

"G" and "H" USED AS COPING. ELIMINATING HORIZONTAL LINES.

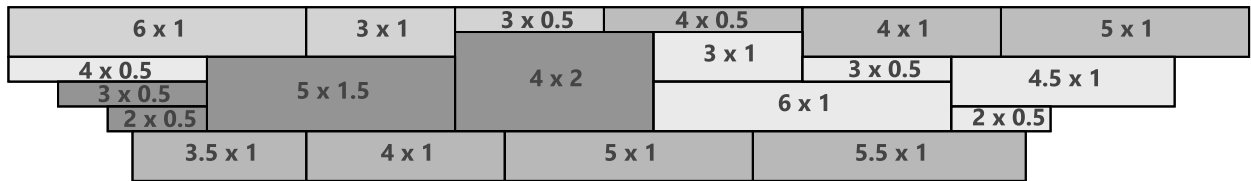

INSIDE CORNER. "CORNER" UNITS ARE NOT NECESSARY AS THE UNITS ARE NOT EXPOSED. THEY WOULD ONLY POSSIBLY BE REQUIRED ON THE TOP FOR AESTHETIC PURPOSES.

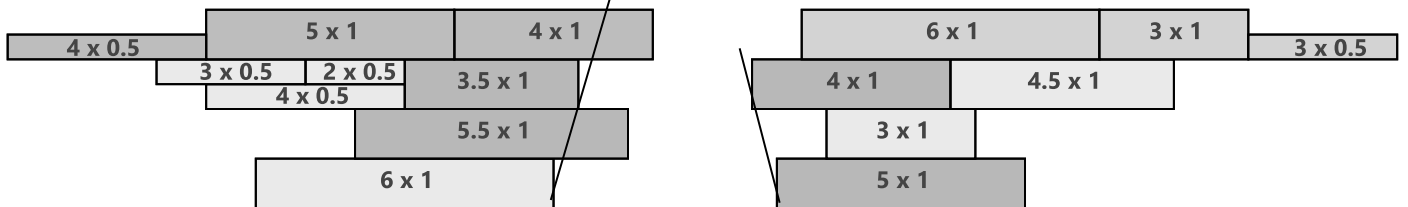

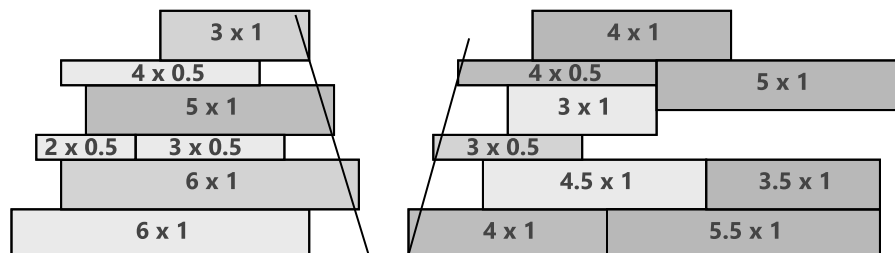

OUTSIDE CORNER USING "G" and "H"



GRAND LEDGE WALL BLOCK DETAILS



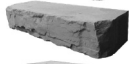

GRAND LEDGE PALLET A	
Pallet weight	± 4000 lbs
Coverage	18 ft. ²

Stone & Bundling	Unit Dimensions ± (inches)			Units Per Bundle	Weight ± / Stone
	W	H	D		lbs
	72	12	23	1	1342
	60	12	23	1	1114
	48	12	23	1	886
	36	12	23	1	658

GRAND LEDGE CORNERS BLOCK DETAILS

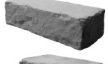

GRAND LEDGE PALLET B	
Pallet weight	± 3644 lbs
Coverage	14 ft. ²





Stone & Bundling	Unit Dimensions ± (inches)		Units Per Bundle	Weight ± / Stone
	W	H		lbs
	50.5	12	1	1190
	46	12	1	885
	42.75	12	1	780
	35.25	12	1	789

GRAND LEDGE COPING BLOCK DETAILS

Coverage	18 ft. ²
----------	---------------------

Stone & Bundling	Unit Dimensions ± (inches)		Units Per Bundle	Weight ± / Stone
	W	H		lbs
	54	12	4	3984

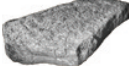
RANDOM STEPS



STONE & BUNDLING	Unit Dimensions		Rise	Weight± / Stone	
	L (inches)	W (inches)		lbs	kg
 Step A	54	34	7"	458	208
 Step B	60	24	7"	600	272
 Step D	48	28	7"	567	257
 Step F	48	24	7"	512	232

Weight ± / pallet 3,195 lbs / 1,450 kg.

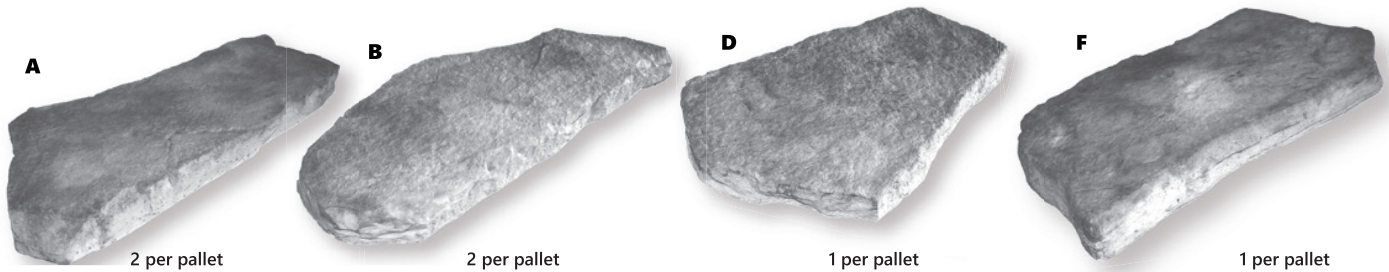
A CLOSER LOOK AT RANDOM STEPS (A, B, D, AND F)



DIMENSIONAL STEPS

STONE & BUNDLING	Unit Dimensions (inches)			Units per Bundle	Weight ±/ Stone		Weight ±/ Pallet	
	L	W	H		lbs	kg	lbs	kg
 3' Long	36	30	7	3	660	300	1,980	900
 4' Long	48	18	7	6	510	232	3,060	1,388
 6' Long	72	30	7	3	1,320	599	3,960	1,797

STEP FILLERS

TYPICAL INSTALLATION DETAIL

4' Step Installation Detail

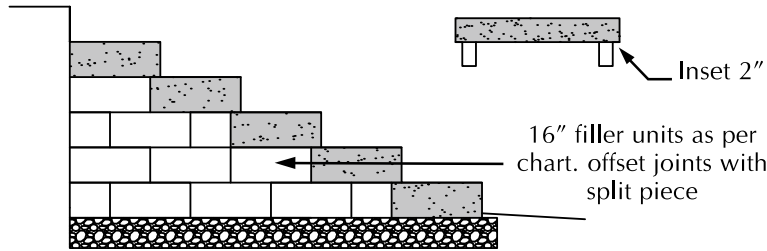

6' Step Installation Detail

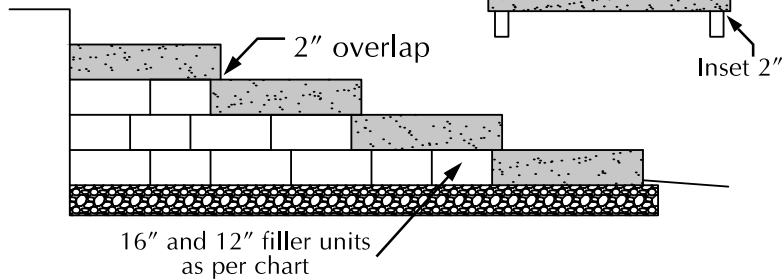

Step Filler Order Chart			
# of Steps	4' Chart		6' Chart
	16" pcs	16" pcs	12" pcs
1	0	0	0
2	1	1	1
3	3	3	3
4	6	6	6
5	10	10	10
6	15	15	15
7	21	21	21
8	28	28	28
9	36	36	36
10	45	45	45
11	55	55	55
12	66	66	66
13	78	78	78
14	91	91	91
15	105	105	105

*These quantities are PER SIDE of the built staircase. When using this chart, "1" will always be the top installed step.

INSTALLATION INSTRUCTIONS

- Ensure a well compacted base of appropriate graded granular base material.
- Ensure adequate drainage that flows away from the installation or construction field.
- Be vigilant and aware of site dangers and always wear appropriate PPE.
- When installing 4' (48") steps, use the 16" step filler units as per the order chart.
- When installing 6' (72") steps, use the 16" and 12" in a 1:1 ratio as per the order chart.
- Fillers are designed to allow a 2" overlap on steps, providing a 16" (4' Step) and 28" (6' Step) tread.
- Alternate tread depths are possible. Units will need to be cut as per contractor design.
- Always glue the units with construction graded masonry/hardscape adhesives.
- Place first step at the bottom of the stair case.
- Place first rows of step fillers behind first step ensuring the fillers are inset 2" from the outermost edge of the step unit (as per cross-section). This allows for aesthetic appeal and proper run-off.
- When placing fillers for 4' step (16" units), every other row will require a unit to be split in half to offset joints for optimal function and appearance. The 16" units are marked for this purpose and to allow for superior drainage behind the wall.
- When placing fillers for 6' step (16" and 12" unit combination), place units at random to offset joints and order as per the order chart.
- Backfill and gently pack material, not to move fillers.
- Check for level and vertical square.
- Place second step and fillers for that row. Regularly check for level, plumb and square.
- Backfill and gently pack material, not to move fillers.
- Continue this cycle to top of staircase.
- If additional support or reinforcement is desired, place an additional row of step fillers up the centre of the staircase as per the order chart.
- When installing staircases over 6 risers, the use of geogrid in behind the fillers every 2 steps to aid in reinforcing the large granular mass is recommended. Cut the grid to fit from the back of the filler units to the structure to the back of the steps.
- Align the geogrid from side to side. A basic retaining wall geogrid would be sufficient. When using geogrid, do not install a middle row of blocks.

12" (30.48 cm) Step Filler
12" x 7" x 4"
30.48cm x 17.78cm x 10.16cm
Weight: 32 lbs/pc
1458 lbs/bundle
44 pcs/bundle
2 layers of 22 pcs each

16" (40.64 cm) Step Filler
16" x 7" x 4"
40.64cm x 17.78cm x 10.16cm
Weight: 42 lbs/pc
1436 lbs/bundle
33 pcs/bundle
3 layers of 11 pcs each

STEP INSTALLATION

CALCULATING TREAD WIDTH

Generally, when the grade allows, a 12" or wider tread is desirable. To calculate the tread width, divide the total allowable horizontal run minus the width of the top step, by the number of steps minus one. The one less will account for the top step.

1. EXCAVATE AND GRADE THE AREA FOR THE FIRST STEP. Steps should be placed on at least 3" of free draining soil, such as sand or pea-stone. Compact soil to a minimum of 95% Standard Proctor.
2. PLACE STEP with either forks or straps using a small excavator or skid-steer to lift the piece into place. Practice safe handling procedures during this process.
3. FILL BEHIND EACH STEP with free draining soil and compact to 95% Standard Proctor. Remember to slope fill to allow for proper drainage when next step is placed. Continue placing steps in this manner until finish grade is reached.
4. Block size and placement shown are for reference only. Individual steps will vary with installation pattern.

Consider the Following Example:



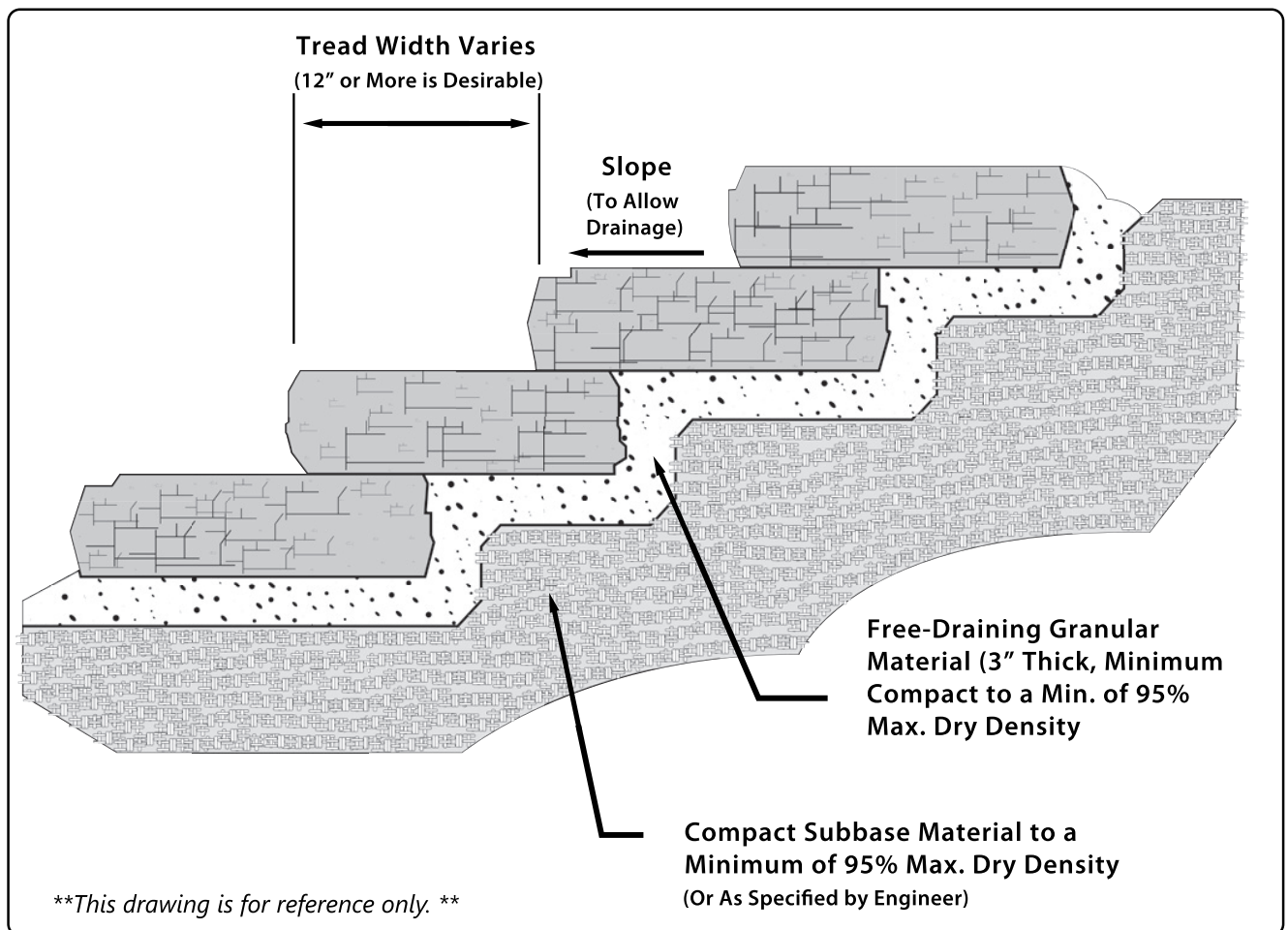

TOTAL RISE	42"
TOTAL HORIZONTAL RUN	96"
WIDTH OF TOP STEP	18"
RISE OF STEPS	7"
NUMBER OF STEPS CALCULATION	$42" \div 7" / \text{Step} = 6 \text{ Steps}$ $\text{Tread Depth} = (96" - 18") \div (6 - 1)$ $= 15.6" \text{ Tread Depth}$



ROCKTON WALL & CORNERS



PALLET A

Wall Pallet Stone & Bundling	Unit Dimensions (inches)			Units per Bundle	Weight ±/ Stone	
	L	W	H		lbs	kg
 Block 1	42	10 1/2	6	6	200	90.5
 Block 2	30	10 1/2	6	3	150	68
 Block 3	21	10 1/2	6	6	140	63.5
 Block 4	12	10 1/2	6	3	50	22.5

ROCKTON WALL PALLET

Pallet weight = ± 2,500 lbs. / 1,125 kg
(incl. pallet weight); Coverage = ± 21 ft.²/pallet
retaining or freestanding wall
Section = 7 ft.² per layer

*Weights of individual
blocks may vary.*

Rockton Wall Blocks are provided in four basic sizes. The blocks are finished on both the front and back faces of the wall blocks and they are tapered on each side approximately 1.5" from the front to the back of the block. There are multiple texture patterns for each basic block size to provide a more random look for your finished project. Average block weights of the different texture patterns are shown. Weights of individual blocks may vary.



PALLET B

ROCKTON CORNER PALLET

Pallet weight = ± 2,500 lbs./ 1,125 kg
(incl. pallet weight); Coverage = 31.5
ft.²/pallet Section = 1.3 ft.² per piece

***Preliminary Cross Sections Available. ***

Corner Pallet Stone & Bundling	Unit Dimensions (inches)			Units per Bundle	Weight ±/ Stone	
	L	W	H		lbs	kg
 Block 1	21	10 1/2	6	24	100	45

The Rockton Collection contains two corner blocks. These blocks are finished on three sides, and the fourth side is tapered to fit with the other retaining wall and freestanding wall blocks. The corner blocks can be used to construct columns, provide a finished end on a freestanding wall, and make 90° corners. There are multiple texture patterns for the faces of both corner blocks, thus providing a more random look for your finished project. Average block weights of the different texture patterns are shown.

EACH BUNDLE CONTAINS 12 RIGHT AND 12 LEFT CONFIGURED CORNERS.

ROCKTON WALL

TYPICAL RETAINING WALL CONSTRUCTION DETAILS

This page shows typical construction details for Rockton retaining walls. These drawings are representative of major components required in wall construction. Specific details including geotextile reinforcement layers, drainage details, soil requirements, etc. shall be per engineered design for wall.

- This drawing is for reference only
- Final design for construction must be prepared by a registered professional Engineer using the actual conditions of the proposed site.
- Final wall design must address both internal and external drainage and shall be evaluated by the Professional Engineer who is responsible for the wall design.

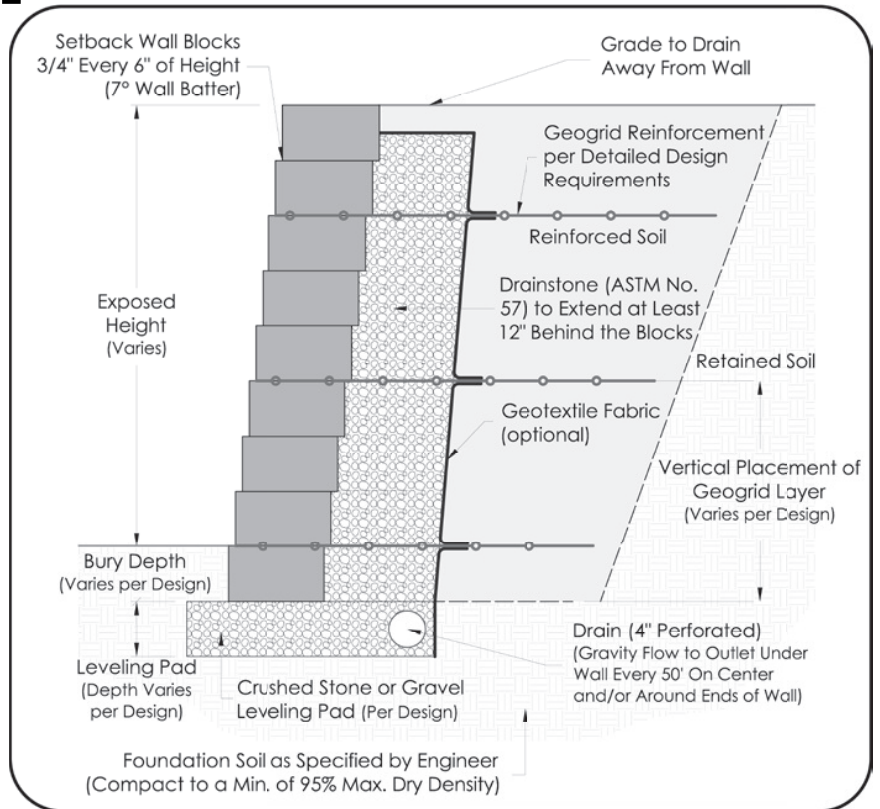

ROCKTON CURVED WALLS

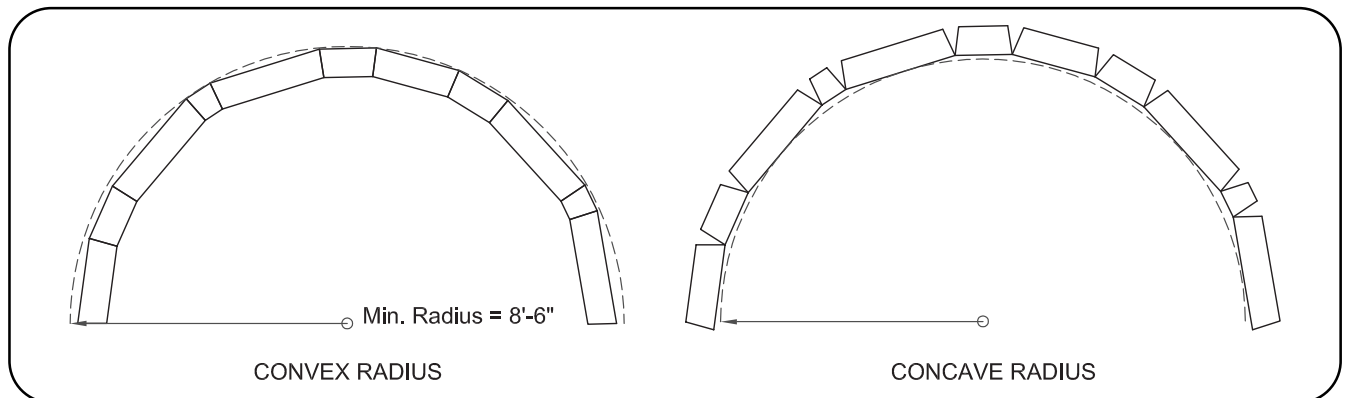

The taper side of Rockton blocks allow for construction of a wide range of curves in both retaining and freestanding walls.

1. Minimum radius curves—shown above—can be constructed without saw-cutting a significant number of blocks. Larger radius curves can be created by leaving a larger gap between blocks on the back side of the wall. The gaps must be filled with Drainstone.
2. When retaining walls are constructed with batter, the radius on outside curves become smaller with each course due to the block setback. For proper construction, the radius of the bottom course must be larger than the minimum radius so upper Courses will have sufficient room for construction.
3. When retaining walls are constructed with batter, the radius on inside curves becomes larger with each course due to the block setback.

NORTHFACE



Half Size Unit	
Length	114 mm (36")
Width	457 mm (18")
Thickness	610 mm (24")
4.5 SQ FT/Unit	
Weight: 1,300 lbs (589.5 kg) solid	

Full Size Unit	
Length	1829 mm (72")
Width	457 mm (18")
Thickness	610 mm (24")
9 SQ FT/Unit	
Weight: 2,600 lbs (1,179 kg) solid	

Note—Northface Coping Options:

****Preliminary Cross-Sections Available****

The 6' Dimensional Step can be used for the coping on this wall system along with a 3' step unit.

SUPERIOR STEPPERS



2" Thickness

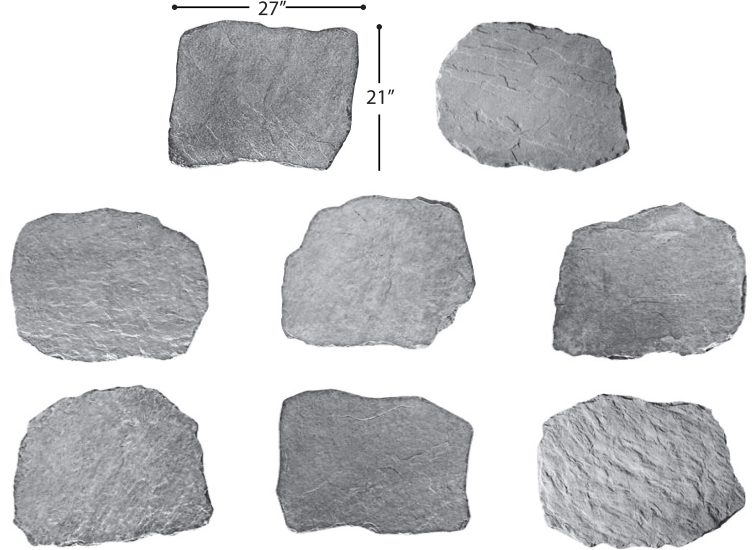

SUPERIOR STEPPERS FEATURES

- 8 different shapes for a rustic, authentic stone appearance.
- Superior Steppers are ± 27" x 21" wide, with a consistent 2" thickness.



Bundle info.	
Sq. ft. per Bundle	~52'
Sq. Ft. per Piece	~3.25'
Pieces per Bundle	16
Weight per Bundle	1,300 lbs / 589 kg

BELVEDERE BLOCK DETAILS



WALL PALLET	
Pallet weight	± 2,475 lbs. (incl. pallet weight)
Coverage	27 ft. ² /Pallet when used in a Retaining Wall ; and 25 ft. ² /Pallet when used in a Freestanding Wall Section = 9 ft. ² per 2 layers (1 Layer of 6" and 1 Layer of 3")

Average block weights of the different texture patterns are shown. Weight on individual blocks may vary.

WALL PALLET Stone & Bundling



Unit Dimensions (inches)			Units per Bundle	Weight ± / Stone	
L	W	H		lbs	kg
6	9	3	12	10	4.5
12	9	3	12	20	9
18	9	3	12	36	16
6	9	6	12	21	9.5
12	9	6	12	42	19
18	9	6	12	67	30

Belvedere Collection wall blocks are provided in six basic sizes. The blocks are finished on both the front and back faces of the wall blocks and they are tapered on each side approximately 1" from the front to the back of the block. There are multiple texture patterns for

each basic block size to provide a more random look for your finished project. Average block weights of the different texture patterns are shown. Weights of individual blocks may vary.



CORNER PALLET

Pallet weight	± 1,520 lbs. (incl. pallet weight)	Coverage	24 ft. ² /Pallet Section = 1.5 ft. ² (One 6" piece & one 3" piece)
----------------------	------------------------------------	-----------------	--

The Belvedere Collection contains 2 corner blocks: these blocks are finished on 3 sides and the 4th side is tapered to fit with the other retaining wall blocks. The corner blocks can be used to construct columns, provide a finished end on a freestanding wall, and make 90° corners. There are multiple texture patterns for the faces of both column block sizes, thus providing a more random look for your finished project. 50% Right, 50% Left configuration.

CORNER PALLET Stone & Bundling



Unit Dimensions (inches)			Units per Bundle	Weight ± / Stone	
L	W	H		lbs	kg
15	9	3	16	30	13.5
15	9	6	16	58	26

BELVEDERE COPING DETAILS (CAPS)



COPING PALLET	
Pallet weight	± 1,550 lbs. / 697.5 kg (incl. pallet weight)
Coverage	66 linear feet/Pallet Section = 11 linear feet per 1 Layer

Coping blocks are provided in five basic sizes. There are three standard coping blocks which are finished on the front, back, and top faces. The standard coping blocks are tapered approximately 1" on each side from the front to the back of the block. There are also two end units which

are finished on the front, back, top, and one of the sides. The other side is tapered approximately 1" from the front to the back of the block. The end units are useful for constructing corners and ends. There are multiple face/texture patterns for each basic block size, providing a more random look for your finished project. Dimensional Coping is also an option for capping the Belvedere Wall. Average block weights of the different face/texture patterns are shown. Weights of individual blocks may vary.

COPING PALLET Stone & Bundling

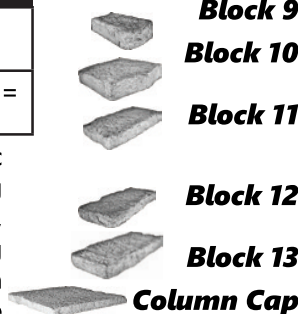

Unit Dimensions (inches)			Units per Bundle	Weight ± / Stone	
L	W	H		lbs	kg
6	10 1/4	2 1/4	24	10	4.5
12	10 1/4	2 1/4	24	20	9
18	10 1/4	2 1/4	12	30	13.5
<i>left end</i>					
18	10 1/4	2 1/4	6	30	13.5
<i>right end</i>					
18	10 1/4	2 1/4	6	30	13.5
27	27	2 1/4	10	150	68

BELVEDERE RETAINING & FREESTANDING WALL INSTALLATION

TYPICAL RETAINING WALL CONSTRUCTION DETAILS

This page shows typical construction details for Belvedere retaining walls. These drawings are representative of major components required in wall construction. Specific details including geotextile reinforcement layers, drainage details, soil requirements, etc., shall be per engineered design for wall.

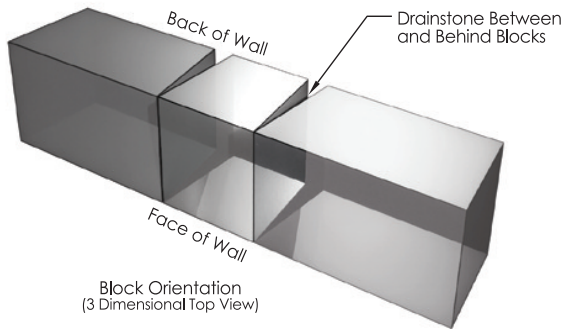

Note: This drawing is for reference only. Final design for construction must be prepared by a registered Professional Engineer using the actual conditions of the proposed site. Final wall design must address both internal and external drainage and shall be evaluated by the Professional Engineer who is responsible for the wall design. Block size and placement shown are for reference only. Individual Belvedere blocks will vary with installation pattern.

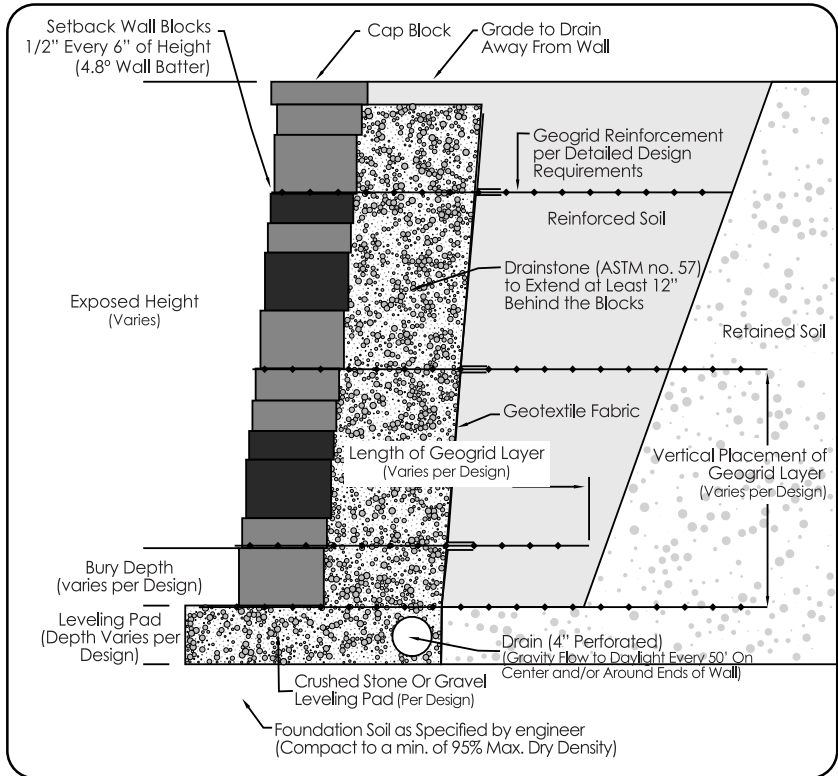

TYPICAL FREESTANDING WALL CONSTRUCTION DETAILS

Belvedere freestanding walls are intended to be low walls (24" or lower) used in a garden or patio setting. Taller walls – i.e. walls intended to act as railing or barriers, walls constructed in other settings, or walls subject to applied loads — will require project-specific engineering.

Block Orientation (top view)

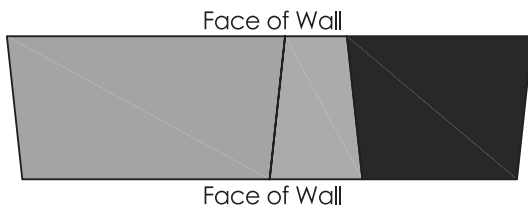

Note: This drawing is for reference only. Final design for construction for walls subject to any loading must be prepared by a registered Professional Engineer. Block size and placement shown for reference only. Individual Belvedere blocks will vary with installation pattern.

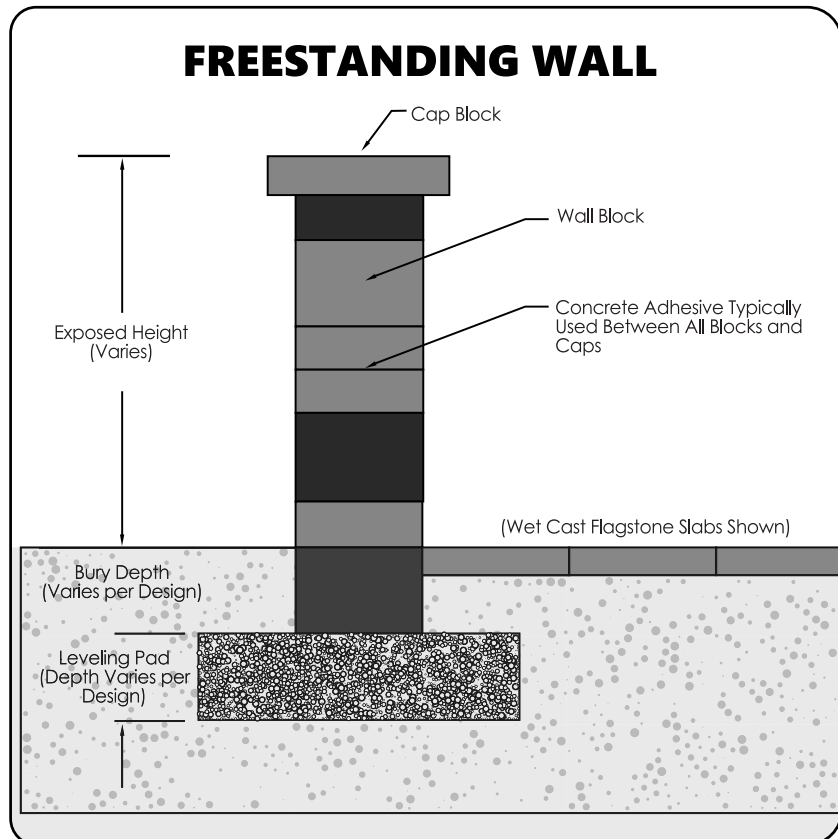

SEE WEBSITE FOR WALL PATTERNS

BELVEDERE CURVES INSTALLATION

This page shows typical construction details for making curved retaining walls with Belvedere blocks. The taper on the side of the blocks allow for construction of a wide range of curves in both retaining and freestanding walls.

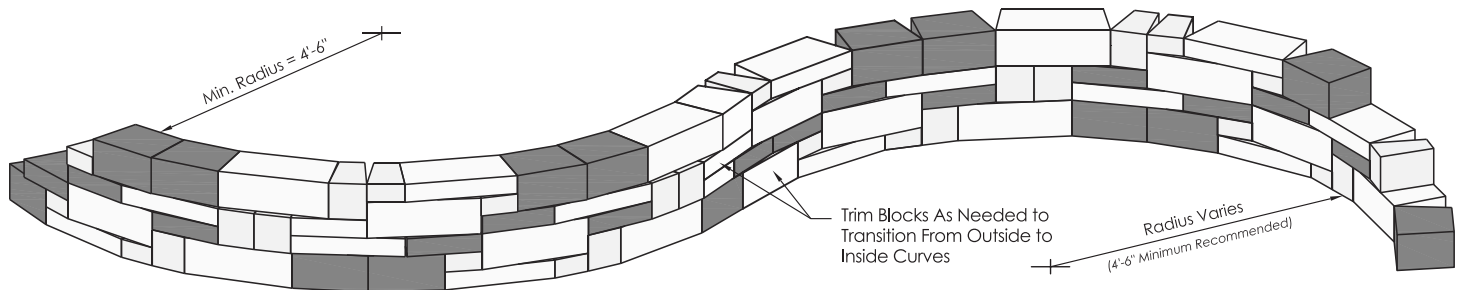

OUTSIDE CURVE

INSIDE CURVE

Note:

1. These details show curved retaining walls.
2. Minimum radius curves are shown which can be constructed without saw cutting a significant number of blocks. Larger radius curves can be created by leaving a larger gap between blocks on the backside of the wall. The gaps must be filled with drainstone.
3. When retaining walls are constructed with batter, the radius on the outside curves becomes smaller with each course due to the block setback. For proper construction, the radius of the bottom course must be larger than the minimum radius so that upper courses will have sufficient room for construction.
4. When retaining walls are constructed with a batter, the radius on the inside curves becomes larger with each course due to the block setback.

CURVED FREESTANDING WALLS

Curved freestanding walls can also be built. Typically, the blocks have to be field-adjusted to make the desired curve. Front and back faces will alternate and blocks trimmed as needed to provide a tight fit between blocks with no gaps on either side of the freestanding wall.

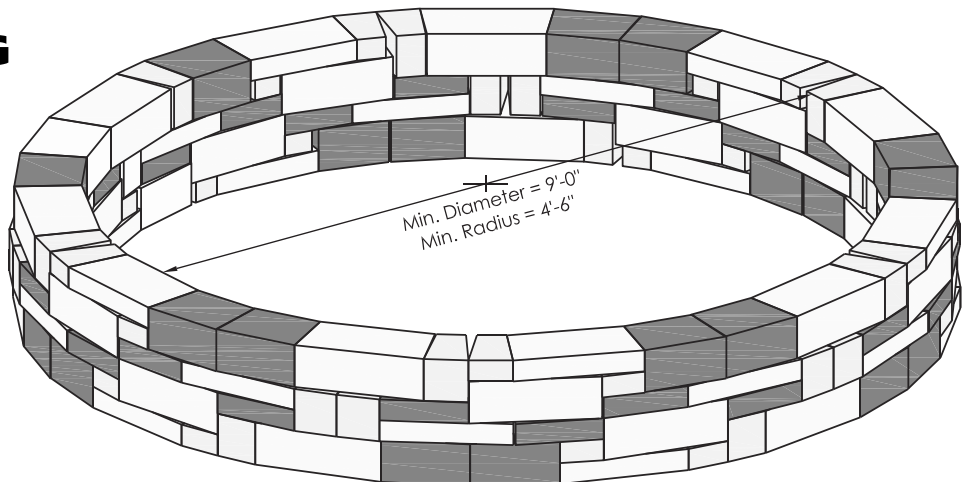

PLANTER/ TREE RING

Note: Walls are shown without batter for clarity. Blocks in a retaining wall should be adjusted slightly in place and trimmed as needed to allow wall construction with proper batter.

BELVEDERE PILLARS INSTALLATION

PILLAR CONSTRUCTION DETAILS

This page shows typical construction details for Belvedere pillars. Pillars make nice ends to Freestanding walls, formal stair openings, stand-alone monuments, and other areas to enhance your Belvedere project. The basic steps of pillar construction are shown here. Feel free to expand on these ideas and bring your own creativity into creating a custom project.

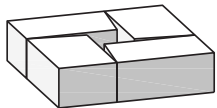

STEP ONE

Place (4) 3" or 6" high corner blocks with the taper facing into the center of the pillar.

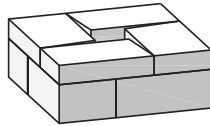

STEP TWO

Place the second row of (4) of the corner blocks with the taper facing into the center of the pillar. Typically, if the first row is built with 6" corner blocks, the second row is built with 3" corner blocks.

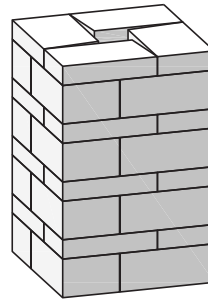

STEP THREE

Continuous with subsequent rows to the desired pillar height. One pallet of corner blocks will make a 24" x 24" x 36" high column.

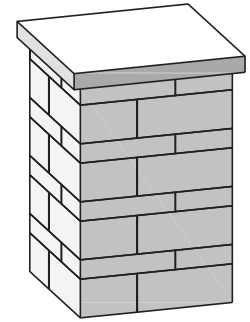

STEP 4

Place a column cap to finish the pillar. The column cap can be cored as needed for installation of a light.

This example shows a freestanding wall with pillars on each end. The wall can either be constructed flush with the pillars, or blocks trimmed to interlock the end of the wall with the pillar.

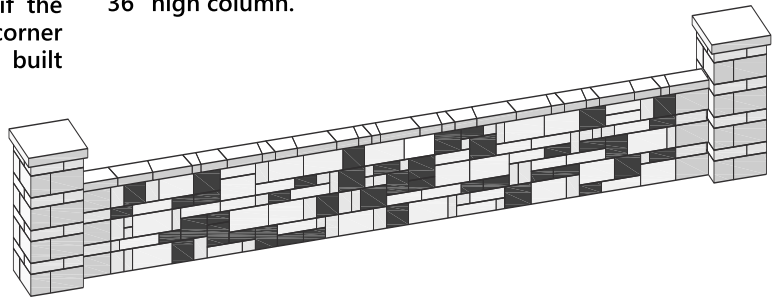

OUTSIDE CORNER

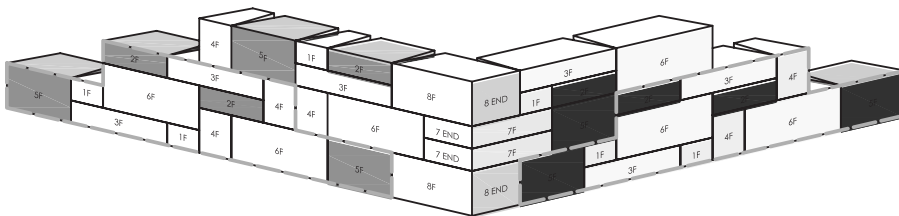

CORNER CONSTRUCTION DETAILS

Some basic concepts are shown here. Plan to take some time to properly work corners into the larger retaining and freestanding wall patterns.

INSIDE CORNER

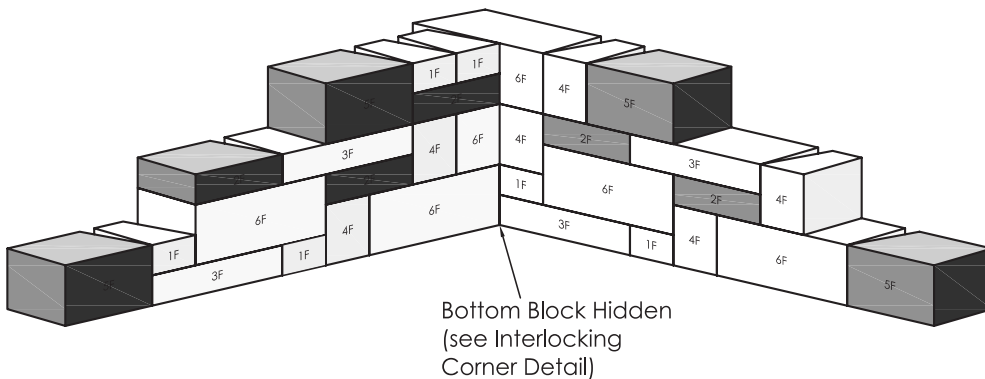

Note: Walls are shown without batter for clarity. Blocks in a retaining wall should be adjusted slightly in place and trimmed as needed to allow wall construction with proper batter.

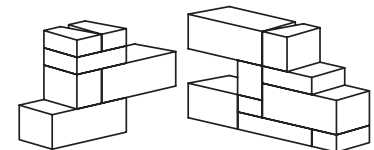

INTERLOCKING CORNER

Place block in an overlapping, interlocking pattern at corner for added wall stability.

DIMENSIONAL WALL BLOCK DETAILS

Stone & Bundling	Unit Dimensions (inches)			Units per Bundle	Weight \pm / Stone	
	L	W	H		lbs	kg
 Straight	12	8	4	75	28	12.5



DIMENSIONAL STRAIGHT PALLET

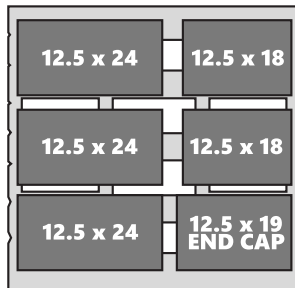

DIMENSIONAL STRAIGHT PALLET	
Pallet weight	\pm 2,100 lbs. (incl. pallet weight)
Coverage	25 ft. ² /Pallet (Retaining) 25 ft. ² /Pallet (Freestanding) Section = Sold by the piece

DIMENSIONAL COPING & CAPS BLOCK DETAILS

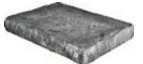

Stone & Bundling	Unit Dimensions (inches)			Units per Bundle	Weight \pm / Stone	
	L	W	H		lbs	kg
 24" Dimensional Coping	24	12 1/2	2 1/2	18	63	28.5
 18" Dimensional Coping	18	12 1/2	2 1/2	12	47	21
 Dimensional Coping End	19	12 1/2	2 1/2	6	49	22

DIMENSIONAL COPING PALLET	
Pallet weight	\pm 1,950 lb / 885 kg
Pallet specs & Coverage	6 Layers per pallet 63 Linear Feet/pallet Section = 10.5 Linear Feet per 1 Layer

DIMENSIONAL RETAINING & FREESTANDING WALL

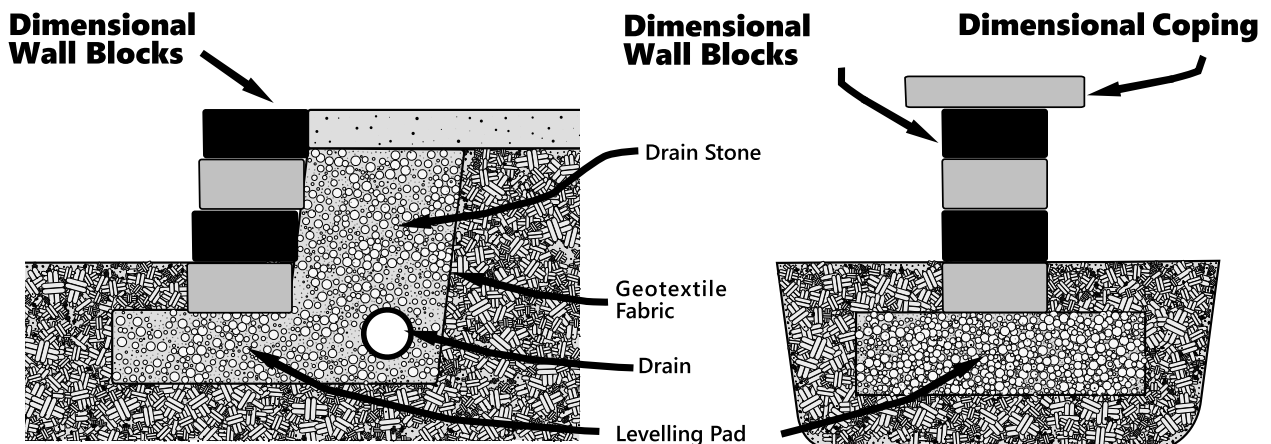

RETAINING WALL

FREESTANDING WALL

WEDGESTONE™



Length: 225 mm tapered to 150 mm
(8.9" tapered to 5.9")
Height: 100 mm (3.93")
Depth: 200 mm (7.87")

Note: all pieces have texture on both sides.

	Resulting Batter	Maximum Exposed Wall Height	Maximum Total Course
Vertical Wall	0°	400mm(15.75")	4 exposed, 1 buried

FACE VIEW OPTIONS — There are two options, depending on how the stones are placed.

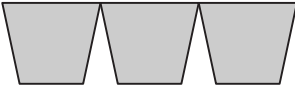
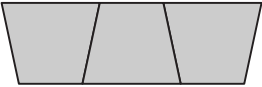
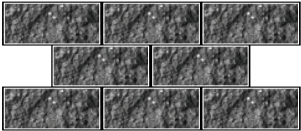
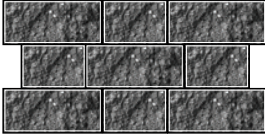
METHOD A - UNIFORM	METHOD B - ALTERNATING FACES
1.35 pcs per linear foot	1.6 pcs per linear foot
	
Top View	Top View
	
Front Face	Front Face

CURVED WALL INSTALLATION DETAILS

4 pieces construct a 90° curved corner with an inside radius of 400 mm (16"). Only 16 pieces are required to construct a full circle with an inside radius of 400 mm (16").

Solid straight wall sections are achieved by simply reversing alternate pieces.

STEP INSTALLATION DETAILS

Curved or half-round steps can be created using Wedgestone™. However, it is recommended that these stones be glued together, that 1.5 courses be buried, and that geogrid be incorporated, to prevent any movement.

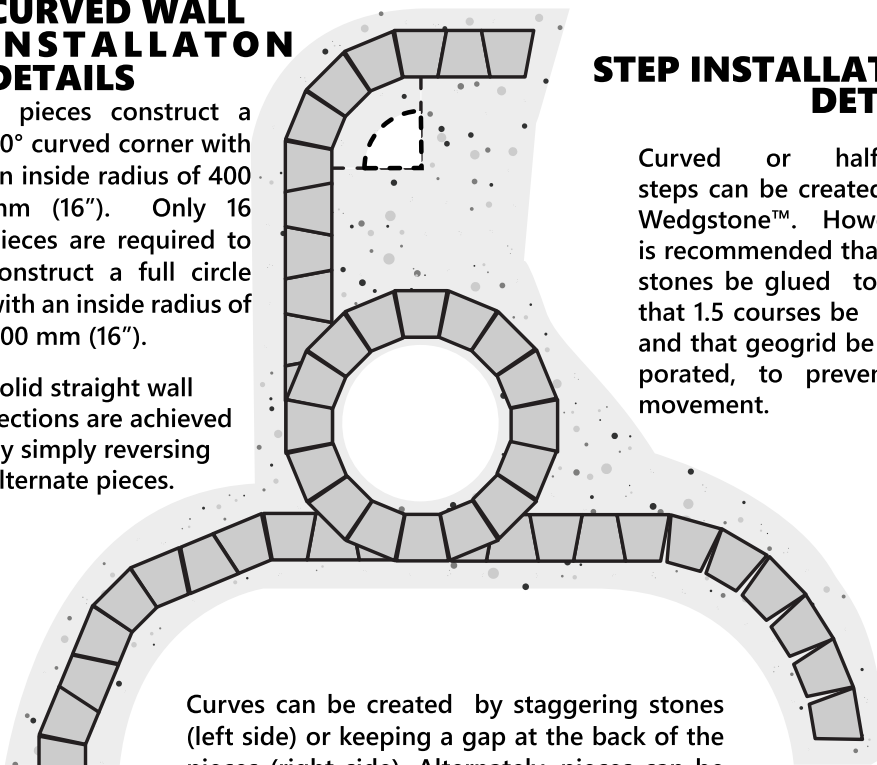

Curves can be created by staggering stones (left side) or keeping a gap at the back of the pieces (right side). Alternately, pieces can be cut as required.

Sq. ft. / Bundle	30 - 36.5
Pieces / Bundle	150
Pieces / Sq. ft.	4.1 - 5
Ln. Ft. / Bundle	94
Weight / Bundle	2850 lbs. / 1293 kg

PARKWALL®



(sold in pairs)



Standard Unit	
Length	200 mm (7.87")
Width	150 mm (5.9")
Thickness	295 mm (11.61")

Corner Units	
Length	295 mm (11.61")
Width	150 mm (5.9")
Thickness	193 mm (7.59")

24" Coping	
Length	600 mm (23.6")
Width	75 mm (2.95")
Thickness	300 mm (11.81")

Pillar Cap	
Length	610 mm (24")
Width	610 mm (24")
Thickness	75 mm (3")

— see catalogue

INSTALLATION DETAILS

The maximum exposed (above grade) height for a gravity wall with a standard 9.5° batter is 975 mm (38.4"). This includes a 75 mm (2.95") cap and 6 exposed courses, and requires one additional buried course. With geogrid, the maximum wall height is 3.375 m (11.1 ft).

The maximum exposed (above grade) height for a gravity wall with no batter is 675 mm (26.6"). This includes a 75 mm (2.95") cap and 4 exposed courses, and requires one additional buried course. With geogrid, the maximum vertical wall height is 2.175 m (7.1 ft). The minimum radius for curves is 2.4 m (8 ft).

RETAINING WALL FACING OPTIONS

Note: With the Park-wall system, both the split face and/or the smooth face can be used on the exposed side.

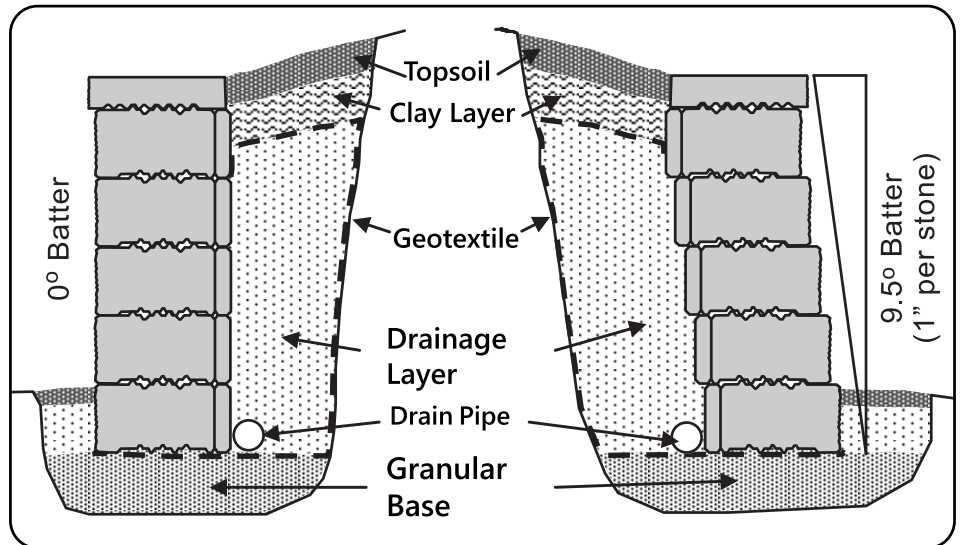

	Standard Unit	Corner Unit	12" Coping
Sq.Ft. per Bundle	19.3	22	13.5
Pieces per Bundle	60	28	28
Pieces per Sq.Ft.	3.1	1.27	2.07
Pieces per Ln.Ft.	1.52	0.625	0.51
Ln.Ft. per Bundle	39.35	44.8	55.1
Weight per Bundle	2,580 lb/ 1,173 kg	1,288 lb/585 kg	1,932 lb/878 kg

PARKWALL® STEPS INSTALLATION

BUILDING STEPS WITH PARKWALL/PARKWALL CLASSIC

When constructing steps, Parkwall Standard units are used for the risers and side walls, while 12" Cap Stone are used for the treads. Standard Units are recommended in lieu of backfill below risers.

Using Pisa Light® for steps is not recommended.

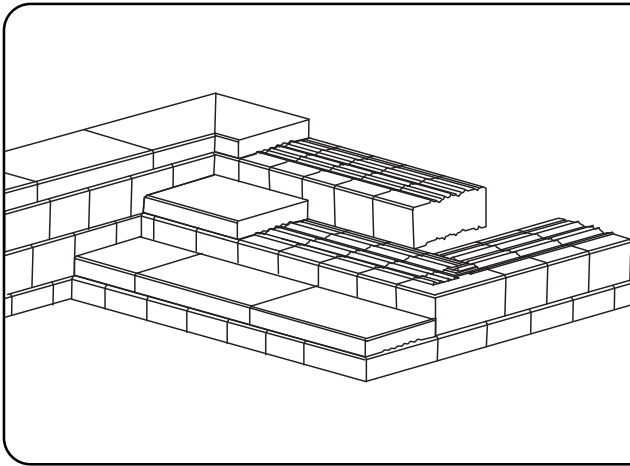

PERPENDICULAR STEPS

This is simply a series of inside and outside covers, with the cross wall (riser) being stepped back 300 mm (12") per course.

For each course, construct the inside and outside corners and then place the necessary units in between. Position the coping units and secure with adhesive.

The next course is placed with the front face of the riser units touching the back of the coping stone on the lower step. Some trimming of the interlock ridges on the outside corner will be necessary.

OUTSIDE STEPS

First, assemble two (2) outside corners and two (2) inside covers for the bottom course. At the outside corners, chop part of the interlock ridges off the corner units and position/secure the coping. Fill in with aggregate or additional standard units.

Place the next riser in contact with the back of the coping unit for the previous riser. Some chopping will again be necessary on the corner units. When constructing vertical sidewall steps against a setback retaining wall, remember to adjust the layout of the inside (back) corners to account for the difference in wall slopes.

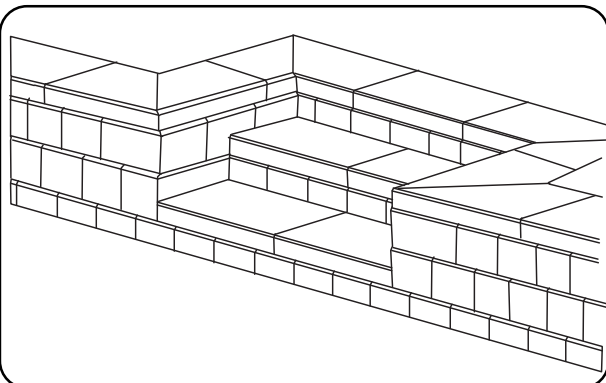
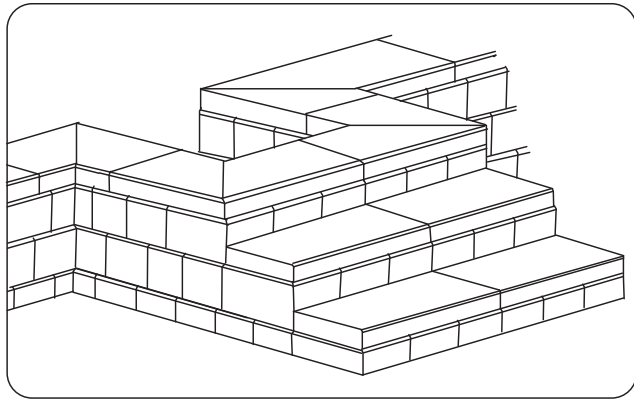

INSET STEPS

First, assembled into outside corners and sidewalls, with a distance of one riser length in between. For setback retaining walls, see previous instructions. Place the first riser and associated filler units on the same foundation elevation as the side walls. Position and secure coping. The next course is placed with the front face of the riser units touching the back of the coping stone on the lower step.

APPIAN 70 & APPIAN 50



Small Rectangle
Length: 330mm (13")
Width: 165mm (6.5")



Square
Length: 330mm (13")
Width: 330mm (13")



Large Rectangle
Length: 495mm (19.5")
Width: 330mm (13")

Appian 70

Bundle contains 9 Layers.

70 mm Thickness	Full Cube	Small Rectangle	Square	Large Rectangle
Sq. Ft./Bundle	95.6	21	42.1	32.5
Stones per Sq. Ft	-	1.7	0.85	0.56
Stones per Bundle	90	36	36	18
Weight per Bundle	2,945 lbs / 1,336 kg	-	-	-
Stones per Layer	-	4	4	2

Appian Soldier Pavers 70mm

70 mm Thickness	Sq. ft. per Bundle	Sq. Ft. per Layer	Soldier per Bundle(LF)	Sailor per Bundle(LF)	Weight per Bundle	Stones per Layer
	95.6	10.62	87.75	175.5	2,746 lbs / 1,246 kg	18

Appian 50

Bundle contains 12 Layers.

50 mm Thickness	Full Cube	Small Rectangle	Square	Large Rectangle
Sq. Ft./Bundle	127.4	28.2	56.5	42.7
Stones per Sq. Ft	-	1.7		0.56
Stones per Bundle	120	48	48	24
Weight per Bundle	2,900 lbs / 1,316 kg	-	-	-
Stones per Layer	-	4	4	2

Appian Soldier Pavers 50mm

50 mm Thickness	Sq. ft. per Bundle	Sq. Ft. per Layer	Soldier per Bundle(LF)	Sailor per Bundle(LF)	Weight per Bundle	Stones per Layer
	127.4	10.62	117	234	3,075 lb / 1395 kg	18

LAYING PATTERNS FOR APPIAN STONE

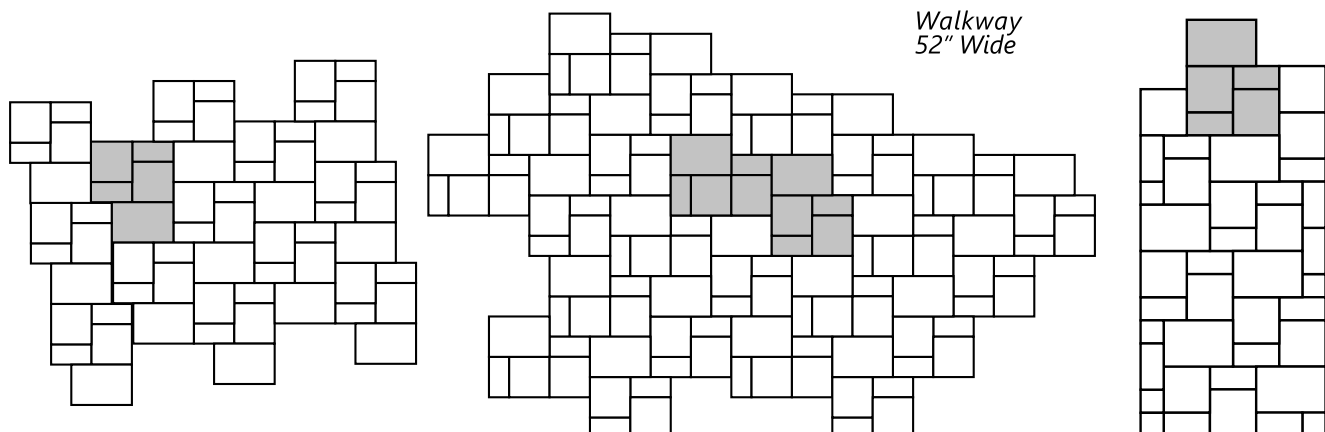

Always Use A Rubber Pad

A rubber pad must be used with a compactor.

Snow removal without a poly (rubber) edge will scar/damage the product surface due to textured finish.

APPIAN XL



Appian XL	
70 mm Thickness	Full Cube
Sq. ft. / Bundle	79.2
Stones / Sq. ft.	0.23
Stones / Bundle	18 pcs.
Weight / Bundle	2692 lbs.
Stones / Layer	2 pcs.

AZTEC XL



Aztec XL	
70 mm Thickness	Full Cube
Sq. ft. / Bundle	79.2
Stones / Sq. ft.	0.23
Stones / Bundle	18 pcs.
Weight / Bundle	2692 lbs.
Stones / Layer	2 pcs.

APPIAN / AZTEC XL and COMBO BUNDLE PATTERNS

Open Permeable
100% XL

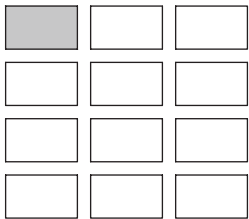

Herringbone
100% XL

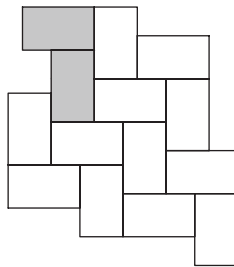

Pattern B
33% XL, 67% Combo Bundle

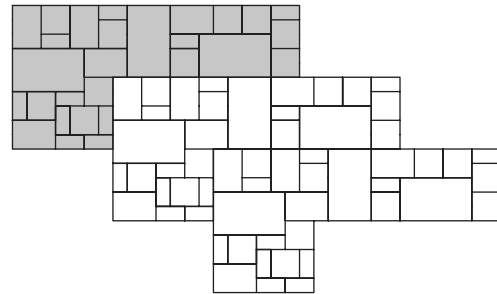

Soldier 1/2 Offset
100% XL

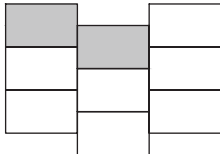

Pattern A
45% XL, 55% Combo Bundle

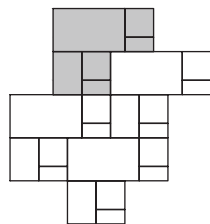

Sailor 1/3 Offset
100% XL

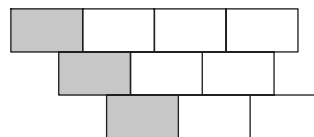

Square Pattern
100% XL

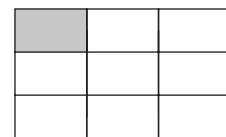

Always Use A Rubber Pad

A rubber pad must be used with a compactor.

Snow removal without a poly (rubber) edge will scar/damage the product surface due to textured finish.

AMBERLEY

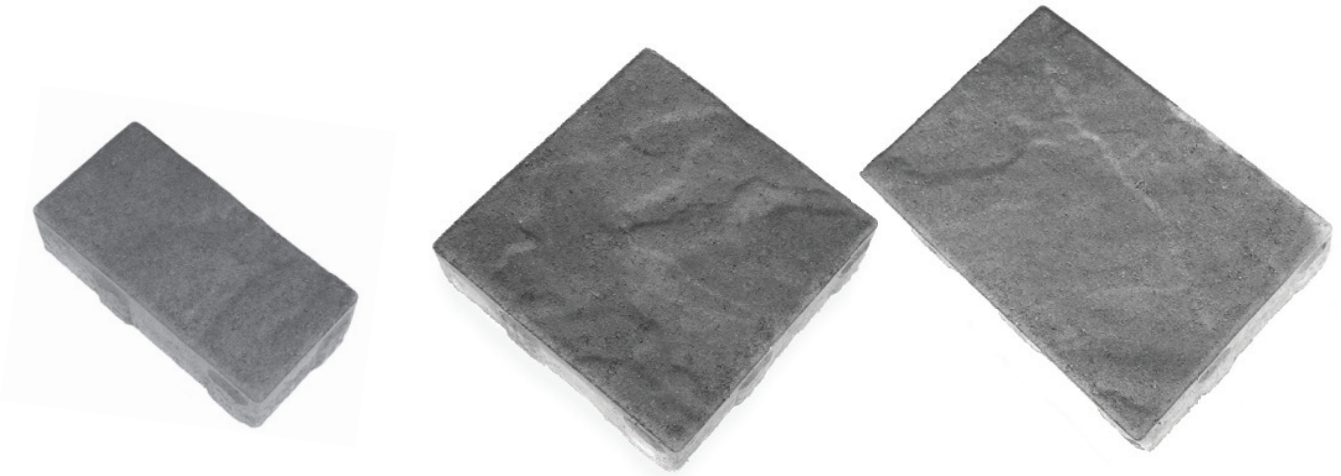

Small Rectangle	
Length	115mm (4.52")
Width	230mm (9.05")
Thickness	60mm(2.36")

Square	
Length	230mm (9.05")
Width	230mm (9.05")
Thickness	60mm(2.36")

Large Rectangle	
Length	345mm (13.58")
Width	230mm (9.05")
Thickness	60mm(2.36")

AMBERLEY PALLET LAYER

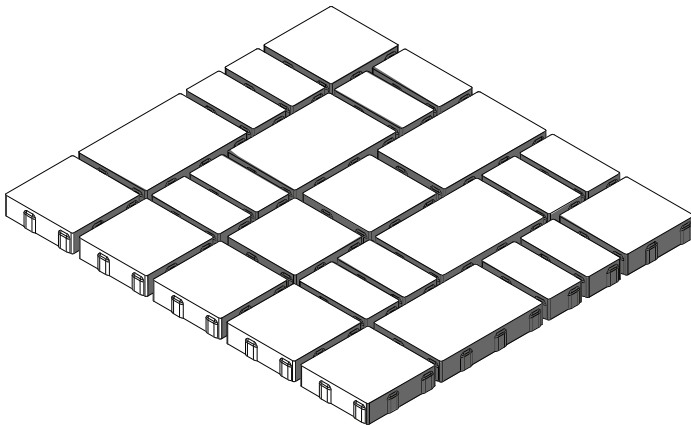

RANDOM PATTERN

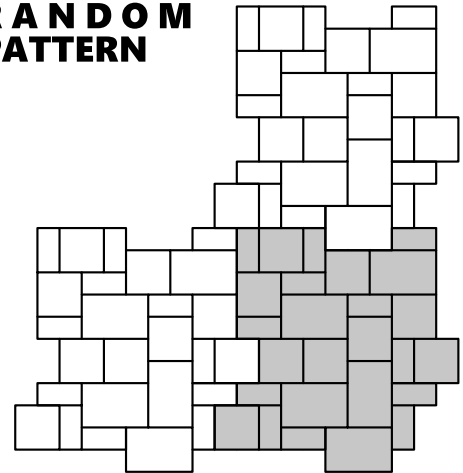

**Linear Patterns Available*

Amberley Pallet Info

60 mm Thickness	Sq. ft. per Bundle	Sq. Ft. per Layer	Layers per Bundle	Weight per Bundle	Stones per Layer
	127.8	12.8	10	3,514 lbs / 1,594 kg	26

Always Use A Rubber Pad

A rubber pad must be used with a compactor.

Snow removal without a poly (rubber) edge will scar/damage the product surface due to textured finish.

AZTEC 70 / AZTEC 50

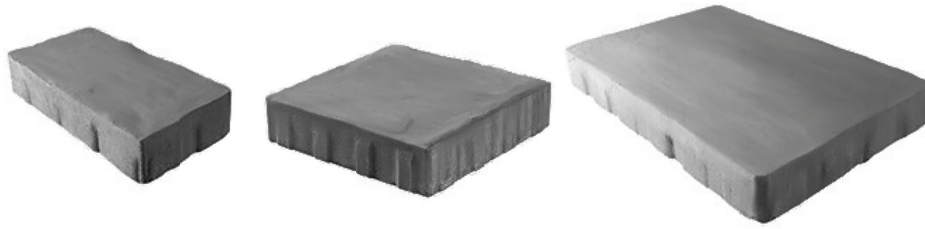

Small Rectangle		Square		Large Rectangle	
Length	330mm (13")	Length	330mm (13")	Length	495mm (19.5")
Width	165mm (6.5")	Width	330mm (13")	Width	330mm (13")

Aztec 70

Bundle contains 9 Layers.

70 mm Thickness	Full Cube	Small Rectangle	Square	Large Rectangle
Sq. Ft./Bundle	95.6	21	42.1	32.5
Stones per Sq. Ft.	-	1.7	0.85	0.56
Stones per Bundle	90	36	36	18
Weight per Bundle	2,945 lbs / 1,336 kg	-	-	-
Stones per Layer	-	4	4	2

Aztec 50

Bundle contains 12 Layers.

50 mm Thickness	Full Cube	Small Rectangle	Square	Large Rectangle
Sq. Ft./Bundle	127.4	28.2	56.5	42.7
Stones per Sq. Ft.	-	1.7	0.85	0.56
Stones per Bundle	120	48	48	24
Weight per Bundle	2,800 lbs / 1,316 kg	-	-	-
Stones per Layer	-	4	4	2

Aztec Soldier Pavers 50mm

50 mm Thickness	Sq. ft. per Bundle	Sq. Ft. per Layer	Soldier per Bundle(LF)	Sailor per Bundle(LF)	Weight per Bundle	Stones per Layer
	127.4	10.62	117	234	2,746 lbs / 1,246 kg	18

LAYING PATTERNS FOR AZTEC 70/AZTEC 50

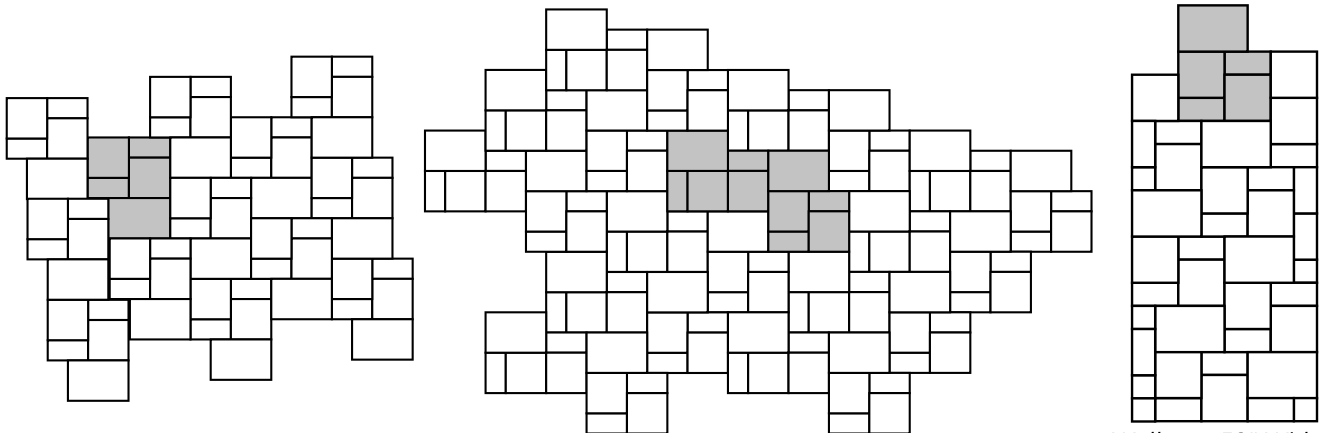

Walkway 52" Wide

Always Use A Rubber Pad

A rubber pad must be used with a compactor.

Snow removal without a poly (rubber) edge will scar/damage the product surface due to textured finish.

ATHENIAN (special order)

ATHENIAN 70MM

70 mm Thickness	
Sq. Ft. per Bundle	96
Sq. Ft. per Layer	12
Layers per Bundle	8
Weight per Bundle	3068lb/ 1,677kg

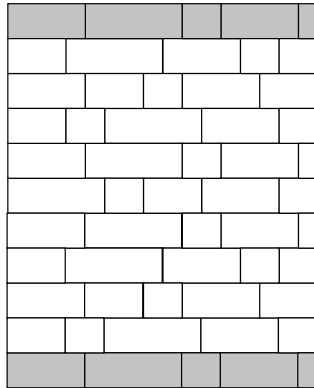

Length	163mm (6.42")
Width	163mm (6.42")
Thickness	70mm (2.76")

Length	245mm (9.65")
Width	163mm (6.42")
Thickness	70mm (2.76")



Length	409mm (16.1")
Width	163mm (6.42")
Thickness	70mm (2.76")

Length	327mm (12.87")
Width	163mm (6.42")
Thickness	70mm (2.76")

AVENNIO (special order)



Length	355mm (14")
Width	115mm (4.53")
Thickness	80mm (3.15")

Length	315mm (12.4")
Width	115mm (4.53")
Thickness	80mm (3.15")

Length	275mm (10.83")
Width	115mm (4.53")
Thickness	80mm (3.15")

Length	235mm (10.83")
Width	115mm (4.53")
Thickness	80mm (3.15")



Length	355mm (14")
Width	85mm (3.35")
Thickness	80mm (3.15")

Length	315mm (12.4")
Width	85mm (3.35")
Thickness	80mm (3.15")

Length	275mm (10.83")
Width	85mm (3.35")
Thickness	80mm (3.15")

Length	235mm (10.83")
Width	85mm (3.35")
Thickness	80mm (3.15")

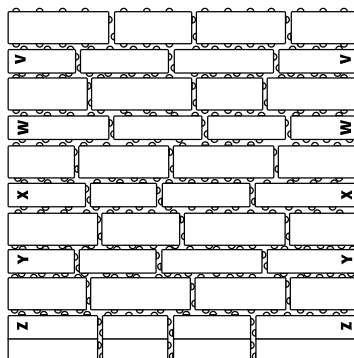

AVENNIO PALLET INFO

Avennio 80mm	
Sq. Ft. per Bundle	95.2
Sq. Ft. per Layer	13.6
Layers per Bundle	7
Weight per Bundle	3,497 lbs / 1,586 kg

NORDIC



Nordic	
Length	200mm (7.9")
Width	100mm (3.9")
Thickness	60mm (2.36")



Nordic 80mm	
Length	200mm (7.9")
Width	100mm (3.9")
Thickness	80mm (3.15")

LAYING PATTERNS FOR NORDIC STONE

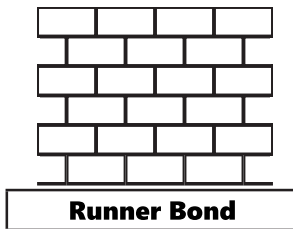

Runner Bond

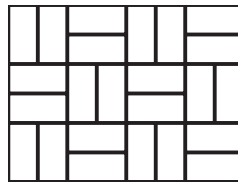

Parquet

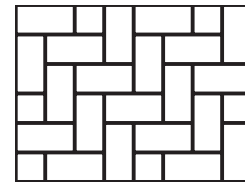

90° Herringbone

	Nordic/Nordic Classic	Nordic 80mm
Sq. Ft. per Bundle	106	93
Full Stones per Sq. Ft.	4.57	4.57
Total Stones per Bundle	495	432
Half Stones per Bundle	18	16
Full Stones per Section	477	416
Sections per Bundle	6	-
Stones per Section	81 (90 with half stones)	-
Sq.Ft. per Section	17.67	-
Ln.Ft. per Bdl (Soldier Course)	156 (full stones only)	139 (full stones only)
Weight per Bundle	2,915 lb / 1,322 kg	3,460 lb / 1,566 kg

Available in a Herringbone configuration for easy machine installation.

**** Nordic 80mm is a Special Order ****

NORDIC SQUARE

** Nordic Square is Special Order **



Nordic Square	
Length	200mm (7.9")
Width	200mm (7.9")
Thickness	60mm (2.36")

	Nordic Square
Sq. Ft. per Bundle	109
Stones per Sq. Ft.	2.29
Stones per Bundle	250
Ln.Ft. per Bdl (Soldier Course)	164
Weight per Bundle	3,052 lb (1,384 kg)

LAYING PATTERNS FOR NORDIC SQUARE

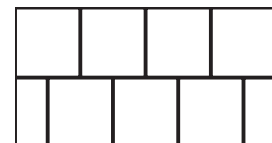

Runner Bond

Other patterns available when combining Nordic Stone and Nordic Square.

DC 80 Permeable Paver System

DC 80	
80 mm Thickness	Full Cube
Sq. ft. / Bundle	73.5
Layers / Bundle	7
Sq. ft. / Layer	10.5
Weight / Bundle	2391 lbs.

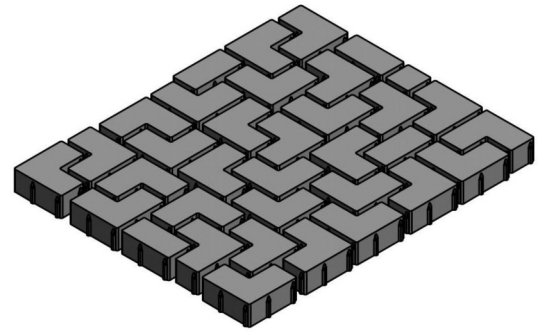

Laying Pattern A - without layer interlock

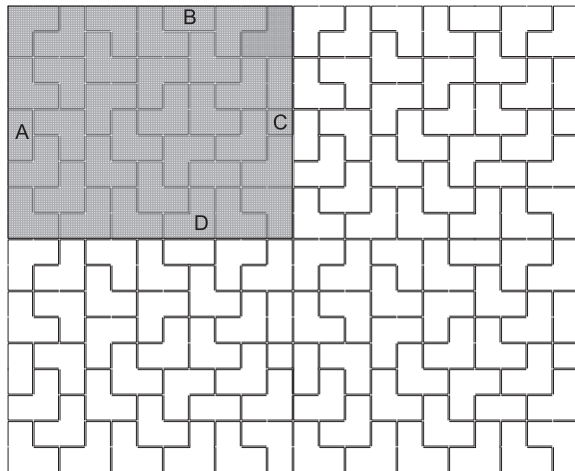

Laying Pattern B - with layer interlock

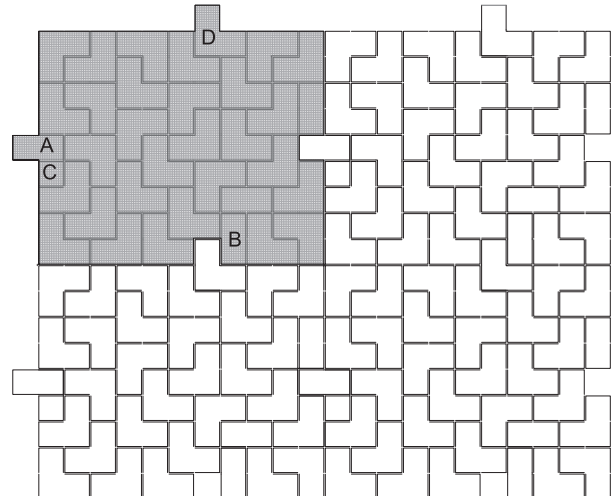

- Permeable Product
- Designed for Mechanical and Manual Installation
- 6% Void Space
- For Standard application, use wide joint permeable jointing material
- For Permeable application, use a clean washed stone chip as specified by designer

Block 1

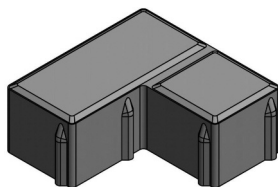

Block 2

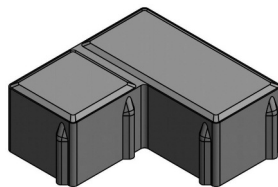

Block 3

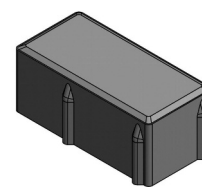

Block 4

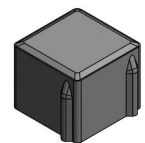

Block Dimensions

Block 1 & 2: 193mm x 193mm (93mm at ends of "L") x 80mm
7.6" x 7.6" (3.7" at ends of "L") x 2.76"

Block 3: 93mm x 193mm x 80mm
3.7" x 7.6" x 2.76"

Block 4: 93mm x 93mm x 80mm
3.7" x 3.7" x 2.76"

AQUAPAVE® PERMEABLE PAVER SYSTEM

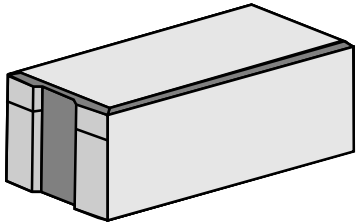

AquaPave®
Length: 200mm (7.9")
Width: 100mm (3.9")
Thickness: 80mm (3.15")

80 mm Thickness	Full Cube
Sq. Ft. per Bundle	73.5
Stones per Sq. Ft.	4.57
Stones per Bundle	336 (8 rows)
Weight per Bundle	2,735 lbs/ 1,085 kg

AquaPave® On-Site Stormwater Source Control System Schematic View

Refer to Aquapave Technical Manual for additional details.

Note: Be sure to determine design requirements, if any, by appropriate government agencies.

Optional Membrane

HDPE (high density polyethylene)
EPDM (ethylene propylene dienemonomer)
ACP-SC1000 or 2000 woven geotextile
ACP-SC Inbitex® Geotextile

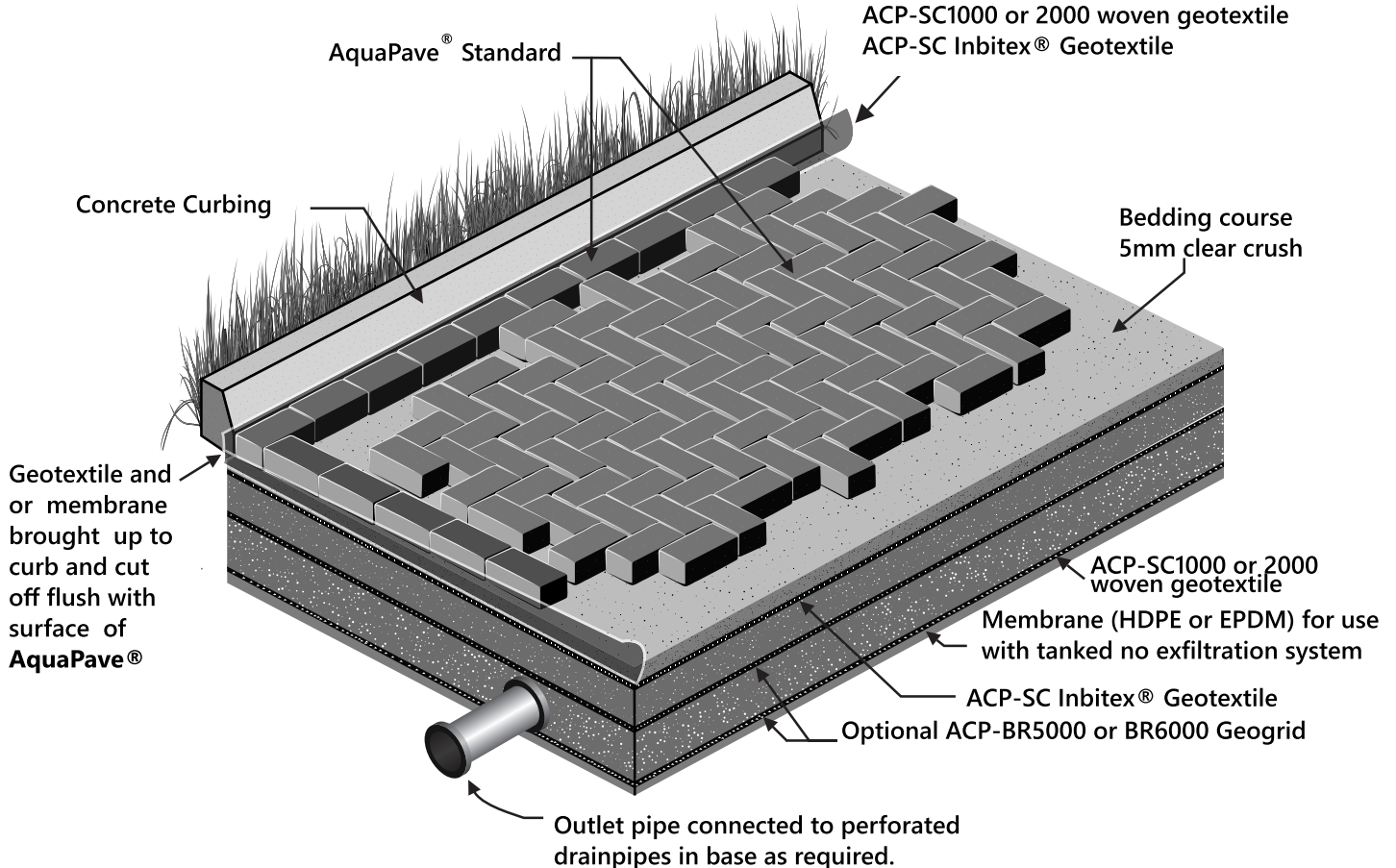

VENETIAN RANDOM

Venetian Random 60 mm				
	Full Cube	Small Rectangle	Large Rectangle	Square
Length per stone	–	2.36 inch	7.1 inch	4.8 inch
Width per stone	–	4.8 inch	4.8 inch	4.8 inch
Sq. ft. per bundle	112	7	62.8	42.2
Stones per bundle	630	90	270	270
Sections per bundle	9	–	–	–
Stones per section	70	10	30	30
Sq. ft. per section	12.45	0.8	6.97	4.68
Weight per bundle	3136 lbs / 1422 kg	–	–	–

Venetian Random Bundle contains these sizes:
Small Rectangle, Square and Large Rectangle

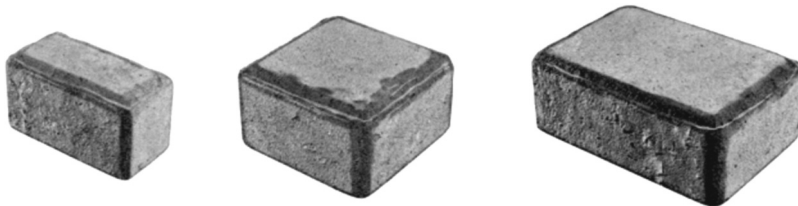

Venetian Random Laying Pattern

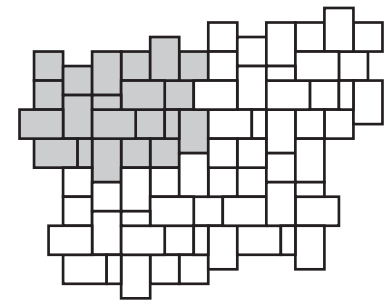

VENETIAN CIRCLE



Square Stone

Length: 120mm (4.8")
Width: 120mm (4.8")
Thickness: 60mm (2.36")

Small Wedge

Length: 90mm (3.6")
Width: 120mm (4.8")
Thickness: 60mm (2.36")

Rectangular Stone

Length: 90mm (3.6")
Width: 120mm (4.8")

Centre Stone

Diameter: 120mm (4.8")
Thickness: 60mm (2.36")

Large Wedge

Length: 130mm (5.1")
Width: 120mm (4.8")
Thickness: 60mm (2.36")

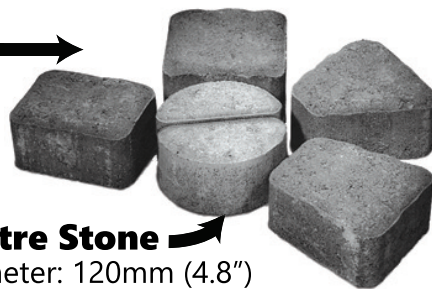

Venetian Circle	Full Cube	Centre Stone	Large Wedge	Small Wedge	Rectangular	Square
Chart Name	-	CS	LW	SW	R	SQ
Sq. Ft. per Bundle	61	-	-	-	-	-
Stones per Bundle	480	8(16 1/2's)	32	192	144	104
Weight per Bundle	1,677lb/ 760kg	-	-	-	-	-

- HELPFUL HINTS** — The following hints are to be used with the Paver Installation Instructions provided on pages 14-15.
1. Circle packs should always be installed starting from the inside (centre stone) and working outwards.
 2. When spreading bedding sand for the centre of the circle, only spread sand over large enough area to allow placement of stones without disturbing material. Spread additional bedding sand as circle progresses outward.
 3. When circle is completed, the remaining area of projects as per normal, taking extra care around circle to ensure lines are maintained. Leave cutting of final filler pieces directly around the perimeter of the circle to the end.
 4. To prevent stones from spreading, do not compact circle into bedding sand until previous step is complete.

Note: there will be some gaps between stones because the circumference of each ring is different.

VENETIAN CIRCLE (Cont'd)

CIRCLE DESIGN CHART

The Venetian Circle bundle can make up to one 2.51m (8 feet 3 inches) diameter circle or up to two 1.55m (5 feet 1 inch) diameter circles.

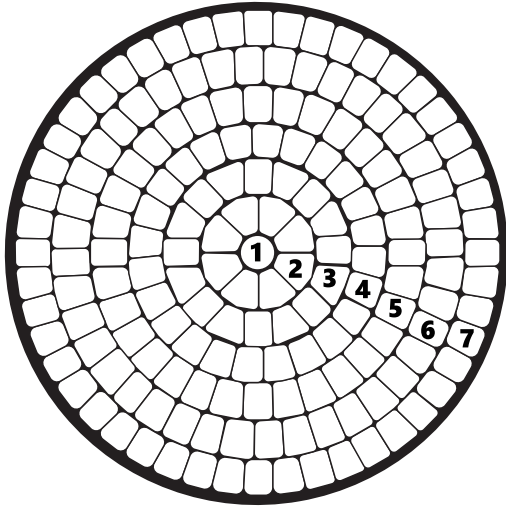

For each 1.55m (5 feet 1 inch) diameter circle, follow this laying pattern.

Ring	Number of Pieces in Ring					Details
	CS	LW	SW	R	SQ	
1	2					
2		8				
3		8		7	1	Alternate LW and R, finish with SQ
4			20		3	Place SQ after every 7 SW
5			20	7	4	SW, SW, SW, R, SW, SW, SW, R, SQ - repeat
6			24	17		SW, SW, R, SW, SW, R -repeat
7			24	24	1	Alternate SW and R, finish with SQ
Total	2	16	88	55	9	

For a 2.51m (8 feet 3 inches) circle, add rings 8 through 11 as follows.

Ring	Number of Pieces in Ring					Details
	CS	LW	SW	R	SQ	
8			24	31	2	SW, R, SW, R, SW, R, R -repeat Place SQ at top & bottom of circle (180° apart)
9			24	40		R, R, SW, R, R, SW, R, SW - repeat
10			32		31	Alternate SW and SQ stones
11			22		45	SQ, SQ, SW, SQ, SQ, SW - repeat
Total	2	16	190	126	87	

SIGNATURE CURB COLLECTION

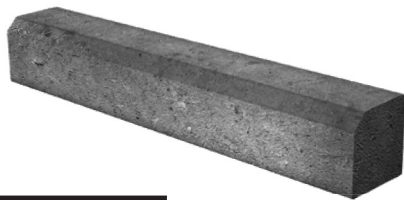

Driveway Curb	
Length	1000 mm (39")
Width	150 mm (6")
Thickness	150 mm (6")



Stone Edge Curb	
Length	914 mm (36")
Width	177mm (7")
Thickness	152mm (6")

	Driveway Curb	Stone Edge Curb	Millstone Curb
Pieces per Bundle	20	20	80
Linear Feet per Bundle	65	60	160
Weight per Bundle	2,200 lb / 997 kg	2,900 lb / 1,315 kg	2,640 lb



Millstone Curb	
Width	100 mm (3.94")
Length	609.6 mm (24")
Height	125 mm (4.72")

BELGIUM



Belgium 6 x 9	
Length	225mm (8.9")
Width	150mm (5.9")
Thickness	60mm (2.36")



Belgium 12 x 12	
Length	300mm (11.8")
Width	300mm (11.8")
Thickness	60mm (2.36")

	Full Bundle
Sq. Ft. per Bundle	122
Stones per Sq. Ft.	4.26 (bundle average)
Stones per Bundle	500
Sections per Bundle	7
Stones per Section	70 (80 in one section)
Sq.Ft. per Section	16.7
Ln.Ft. per Bdl	236 (full stones only)
Ln. Ft. per Section	33.7 (29.5 in one section)
Weight per Bundle	3,371 lb/ 1,529 kg

	6 x 9 Full Bundle	12 x 12 Full Bundle
	105	117
	2.67	1.03
	280	120
	7	4
	40	30
	15	29.3
	165.2	118.5
	23.6	29.6
	2,889 lb/ 1,310 kg	3,218 lb/ 1,459 kg

Belgium 12 x 12 not recommended for heavy vehicle applications.

LAYING PATTERNS FOR BELGIUM STONE

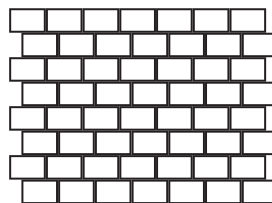

Runner Bond

GRAND FLAGSTONE BLOCK DETAILS

Outside dimensions of each layer are identical to all other layers, allowing any layer to be used anywhere in the pattern. Two (2) of each layer shown below are included in each pallet (8 layers total per pallet).

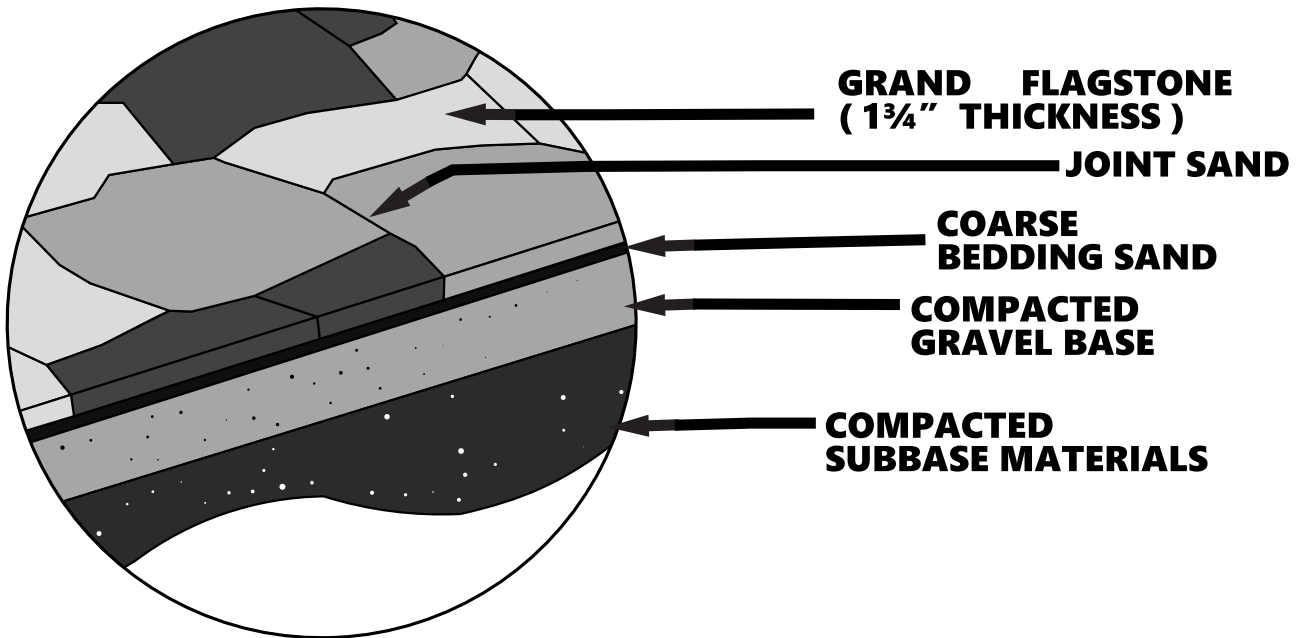
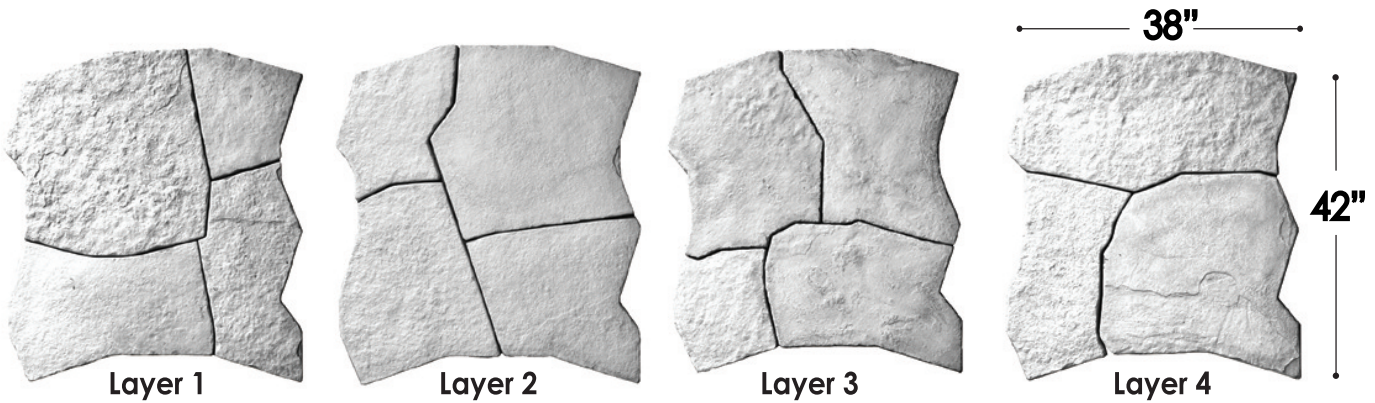

GRAND FLAGSTONE PALLET

	Bundle info.
Layers Per Pallet	8
Pallet Weight	± 2,100 lbs / 953 kg (incl. pallet)
Coverage	90 sqft/pallet
Section Coverage	11 sqft per/layer

GRAND FLAGSTONE INSTALLATION

BEDDING SAND INSTALLATION:

Using screed rails on the compacted granular base, apply bedding sand at a maximum thickness of 1" (25 mm). By using a screed board along the top of the screed rails, the bedding sand will level evenly. Bedding sand should be compacted since Grand Flagstone slabs should not be compacted after installation.

FLAGSTONE INSTALLATION:

1. Begin by laying the individual pieces of Grand Flagstone on the screeded bedding material according to your detailed project plan.
2. Separate individual pieces approximately $\frac{3}{8}$ " (10 mm) from each other. When units are set with a $\frac{3}{8}$ " gap, a full pallet will produce 90 ft.² (8.36 m²) coverage.
3. Cut units as needed to finish edges.

NOTE: To ensure proper colour distribution, mix layers from several bundles at one time.

JOINT SAND INSTALLATION:

Once the flagstone pieces are installed, fill all joints with jointing sand suitable for large joints. Sweep the sand into the joints between flagstones until the joints are completely filled. Follow the jointing sand manufacturer's recommendations for wetting the sand. You may need to repeat this process with more dry sand in a few days to completely fill the joints between individual slabs.

CAUTION: Grand Flagstone slabs should not be compacted after installation.

OTHER CONSIDERATIONS

SEALING: You may want to apply a sealer to protect the flagstone slabs from spills and stains. Always use a high quality sealer specifically formulated for wet-cast concrete.

**** NOT SUITABLE FOR VEHICULAR TRAFFIC ****

TYPICAL CROSS-SECTION

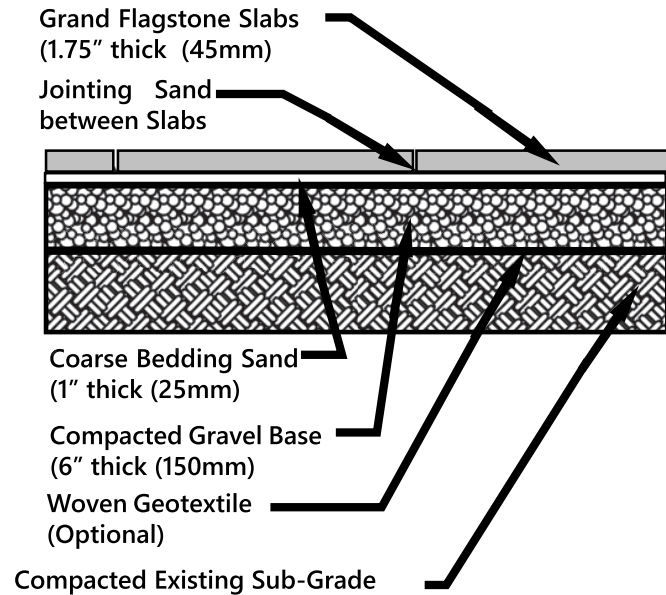

STRAIGHT WALKWAY INSTALLATION

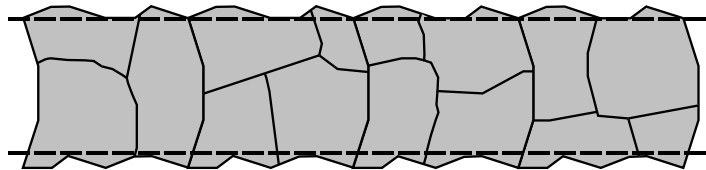

Leave Jagged Edge or Trim to Provide Smooth Edge (Optional)

PLACING GRAND FLAGSTONE

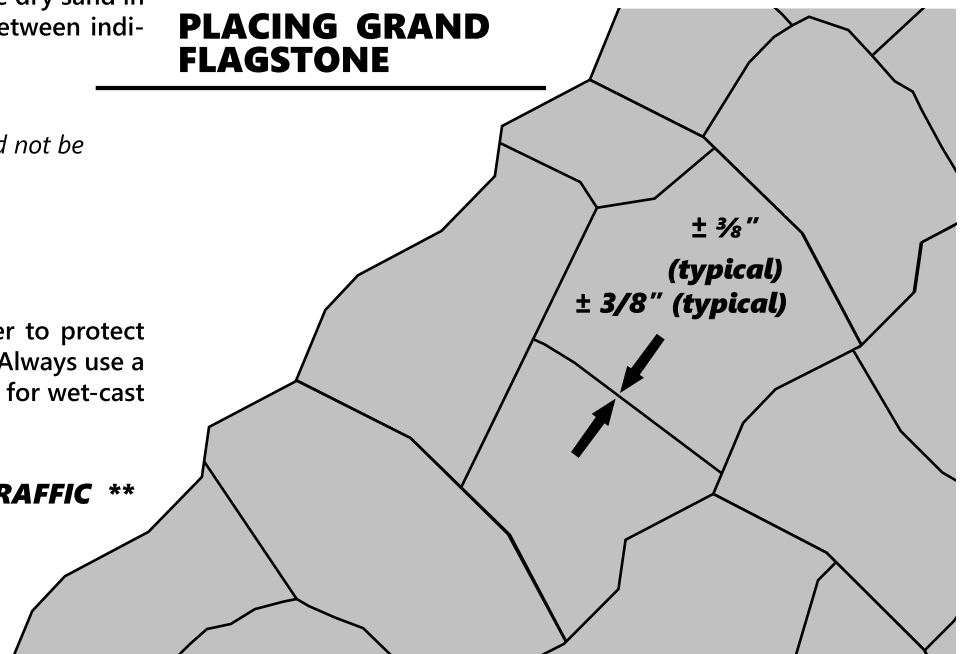

GRAND FLAGSTONE

INTERLOCKING LAYERS:

Grand Flagstone has been designed so that each layer of slabs on pallet is an interlocking set. Each interlocking set, or layer, of slabs has been designed to interlock with all other layers.

COMMON POINTS FOR INTERLOCKING LAYERS

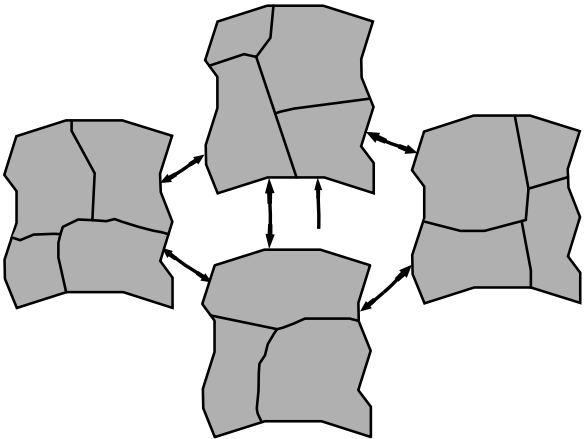

PROPERLY PLACED INTERLOCKING LAYERS

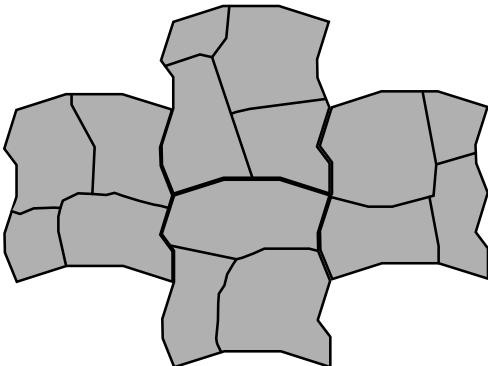

INSTALLING CRACKED PIECES

Individual pieces of Grand Flagstone can crack either during delivery to the job or during on-site handling prior to placement. Typically less than 5% of the pieces will crack. There are two methods to deal with cracked pieces.

The **first method** is to use the cracked pieces to fill in around the edges of the project where there is always a need for small pieces. The **second method** is to use the cracked pieces to enhance the layout pattern.

Since Grand Flagstone is designed to create an irregular flagstone walking surface, an extra crack simply provides another joint line in the Grand Flagstone pattern. Place the cracked pieces next to each other with a $\frac{3}{8}$ " (10 mm) joint between them. The joint is filled with polymeric jointing sand just like all other joints. If necessary, the cracked pieces may need to be trimmed to create a smooth edge or provide a larger joint to match all the other joints in your project.

LAYOUT ORIENTATION:

Layout orientation is important with Grand Flagstone. Due to the nature of the interlocking sets of slabs, there are long, unbroken joints between rows. Often, the irregular nature of the Grand Flagstone limits how noticeable these unbroken joints are in the finished project. However, the lines become slightly more noticeable when you are looking parallel to the unbroken joints than when you are looking at them on an angle. To limit this effect, Grand Flagstone layers should be laid at a 45° angle from the most common viewing angle. This viewing angle would most likely be a patio entrance or step location.

INCORRECT VIEW

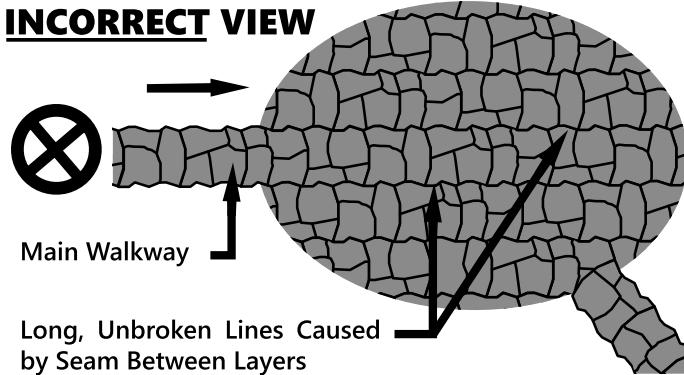

CORRECT VIEW

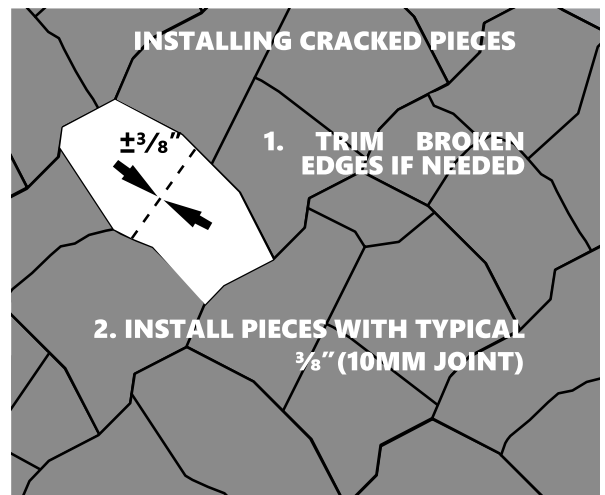
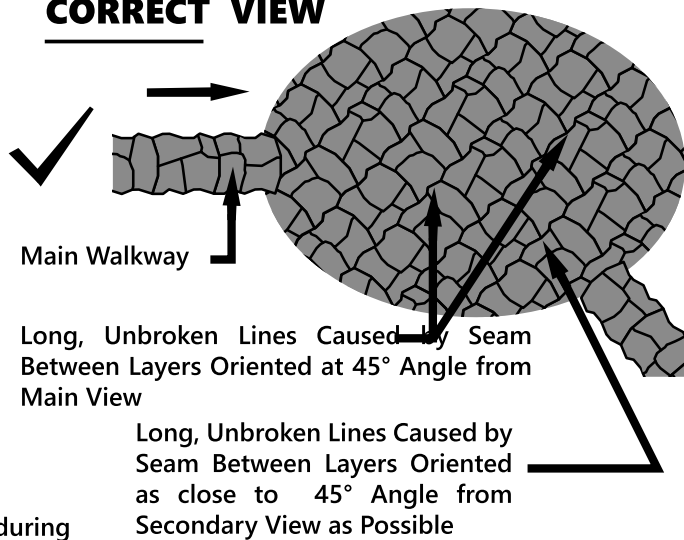

FLAGSTONE & PAVER INSTALLATION GUIDE

Thank you for your interest in installing Brown's paving products. You will find that these products truly combine the look of natural stone with the efficiency and consistency of concrete pavers. The following guide lays out proper installation techniques for Brown's Grand Flagstone. For optimal color blending you must mix and install products from several different pallets simultaneously. We hope this provides helpful tips for a fast, enjoyable installation.

SAFETY

Make safety a top priority when installing Brown's paving products. Before starting your project, be sure to address the following points:

1. Contact your local utility marking service prior to making any excavation. Be sure to follow all governmental safety regulations.
2. Always wear the appropriate personal protective equipment (PPE) including gloves, steel toed boots, safety glasses, hearing protection, and any other needed safety gear.
3. Flagstone slabs are heavy. Follow proper lifting techniques to avoid back injury. Also, use two people to set larger pieces.

PROJECT PLANNING

The first step in installing Brown's paving products is to plan your project. Paver layout and placement is important to ensure a functional and good-looking installation. Remember, Brown's flagstone products are suitable for pedestrian loading only (patios, walkways, etc.) and will not support the load of a vehicle.

EXCAVATION AND BASE PREPARATION

Once you are ready to start construction, you will need to lay out the project area:

1. Mark out the area of the installation with marking paint.
2. Mark a second line 12" (305 mm) outside of the first line that indicates the area to be excavated. This over-excavation will allow for proper base installation.
3. Excavate to the required depth and grade for the installation of the specific paving product you are installing (see cross-sections for minimum recommended excavation depths).
4. Once the excavation depth has been established, compact the subgrade well using a plate tamper. At this point, Brown's Concrete Products Limited recommends laying a woven geotextile down before applying any granular base materials.

PERMEABLE INSTALLATIONS: *Unless specified, avoid compaction of existing subgrade soils if installing a permeable pavement.*

PLACE THE COMPACTED GRAVEL BASE

For standard paver and flagstone installations, begin by spreading half of granular base material in the excavation.

Note: *lifts should not exceed 6" (150 mm) in thickness.*

Compact this first lift to 98% Standard Proctor density using a plate tamper and adding water as needed. Add the second lift of granular material and compact it in the same manner as the first. For permeable paver installations, install open-graded sub-base and base course material as specified in the project drawings.

KEY POINT: *When installing granular base materials, be sure to consider proper grades to prevent water from standing on the surface and make sure that water is directed away from building structures.*

PAVER INSTALLATION

Bedding material requirements and paver installation vary by product type. Please see the following product-specific installation instructions and tips for more details on paver installation.

FIRE PIT KITS



*** BELVEDERE PIT**
Pallet Weight: ± 1320 lbs. / 598 kg

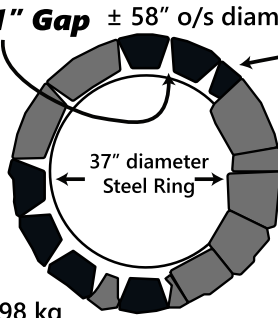

± 1" Gap ± 58" o/s diameter
37" diameter Steel Ring
Blocks
Cap Layer Blocks shown for reference

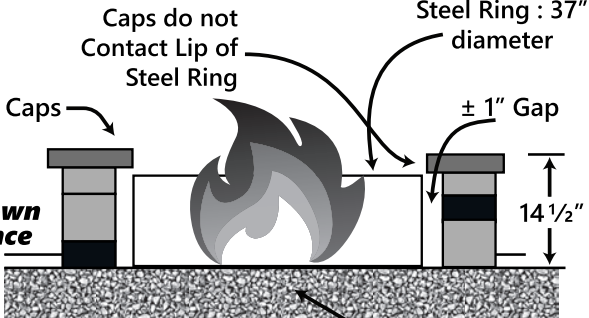

Caps do not Contact Lip of Steel Ring
Steel Ring : 37" diameter
± 1" Gap
14 1/2"
Drainstone

PATTERN BLOCK LAYOUT



BLOCK KEY

17"x 6"	11 1/2"x 6"	6"x 6"	17 1/2"x 3"	11 1/2"x 3"	6"x 3"	CAP

*** DIMENSIONAL PIT**
Pallet Weight: ± 1130 lbs.



512 kg

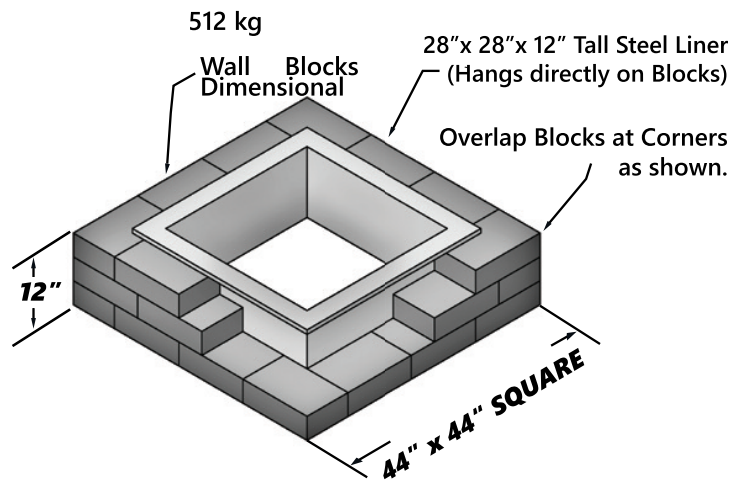

*** ROCKTON PIT**
Pallet Weight: ± 1130 lbs. / 512 kg

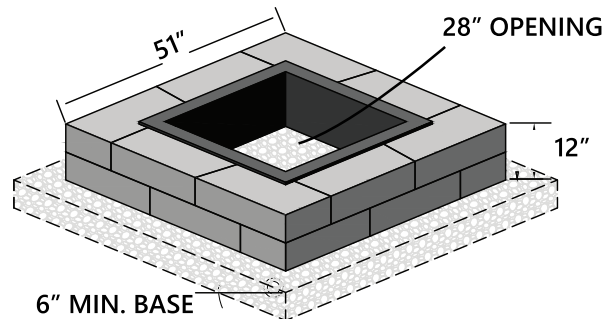



Fire Pit metal insert may vary from that pictured above.
Gas Conversion Kits Available.

NOTE: Not suitable for large fires. Fire size should not allow flame to contact Caps on Round Fire Pit.

See website for additional information.

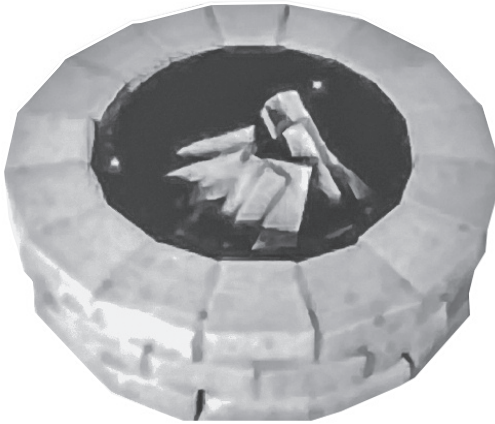
OXFORD FIRE PIT KIT



* OXFORD FIRE PIT KIT

The Oxford Fire Pit Kits is a great fire pit for a smaller space. With its smaller design, and low-profile, it is perfect for a small yard or patio. The gentle features of a round fire pit allow it to blend in with a wide variety of architectural styles.

Packaging Details: Stone and Ring Included on one pallet.
Weight: 1,037 lbs / 470 kg

** Steel insert may not be exactly as shown.*

OXFORD PIT INSTALLATION INSTRUCTIONS:

STEP 1 Set the ring on a flat even surface.

STEP 2 Lay out the first course of 16 blocks around the ring insert.

STEP 3 Make sure the gap between the ring and blocks are even all around, and that the ring can be removed with ease.

STEP 4 Remove the ring insert and set it aside.

STEP 5 Lay out the next 3 courses keeping the joints staggered.
Important: Fire Resistant Masonry adhesive should be applied between layers, securing them in place permanently.

STEP 6 Fill the inside with the 3 bags of sand are required, and spread it out evenly.

STEP 7 Set the ring back inside the firepit and press it down to set it in the sand. It should sit just below the rim of the firepit blocks.

Also available the Kent II Fire Pit

ANTICO STACKER



Size: 11.81" w X 3.92" h X 7.87" d
 (300 mm X 100 mm X 200 mm)

Antico Stacker	
Weight per unit	29.8 lbs (13.5 kg)
Weight per skid	2861 lbs (1297.6 kg)
Pieces per skid	96
Pieces per layer	16
Layers per skid	4
Coverage per skid	31 ft ² / 20.67 ft ²
Lineal Coverage	94.5 ft / 63 ft
Coverage per section	7.75 ft ² / 5.17 ft ²
Lineal Coverage per section	23.62 ft / 15.75 ft

GENERAL PAVER INSTALLATION

1. Planning:

Outline the proposed area of construction with a garden house and then park vehicles (for driveways) or place furniture (for patios) in the area to ensure that the final product is adequately sized. Once everything looks fine, transfer the information on paper.

2. Excavation & Base Preparation:

The depth of excavation will depend upon the project and soil conditions; a driveway excavation is typically 400-600mm (16" – 24") in depth, while a walkway or patio excavation is normally 200-250mm (8" – 10").

To provide a secure base in which to install the edge restraint, the area of excavation needs to be larger than the area being paved; the rule of thumb is to extend the excavation outwards in all directions equal to the total depth of the excavation.

Prior to starting the work, place stakes at each end of the job and run string lines between them to represent the desired final grade; ensure a minimum slope of 1mm per 100mm (1/8" per 12") for proper drainage away from your home. While excavating, use a measuring tape to verify depths of the string lines. When excavating is completed, remove any debris and then compact the native material with a minimum 7,000 lbf tamper. Spread the backfill material in loose layers of no greater than 150mm (6"), wet the material with water (helps increase in compaction) and compact into place. Continue this process until within 85mm (3 1/3") of final proposed grade. Run a 3mm long straight edge over the compacted area to detect any high/low spots.

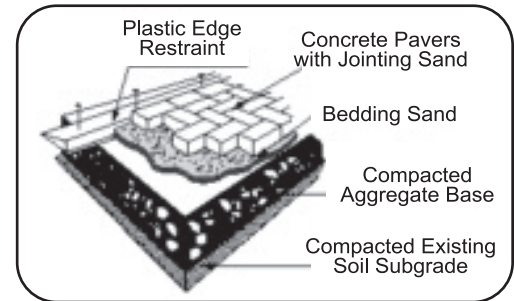

3. Edge Restraints:

Lay a row of pavers from one side of the area to the other and then position your curbs accordingly to avoid unnecessary cuts. For concrete curbs, dig a trench to the required depth (subject to final placement level of curb), place the curbs and then backfill to original base grade. For plastic edging, the sections are positioned directly on top of the base and then staked into place using 250mm (10") spikes.

4. Bedding Sand:

The key is to ensure a consistent thickness for the loose sand. The easiest way to do this is to use 25mm (1") diameter Schedule 80 PVC pipe for guard rails (the outside diameter is 35mm). Spread the sand loosely between a pair of pipes, then pull a straightedge along the top to level sand out. Avoid disturbing the sand once in place.

5. Laying the Pavers:

The laying pattern used is subject to personal preference; however, herringbone patterns are recommended for traffic areas. Place chalk lines on the sand at 2m (6') intervals to provide straight line guides during installation. Always start laying at the lowest point so that stones cannot separate; place hand tight. Use a rubber mallet as required to adjust stones. While laying, mix pavers from at least 4 different cubes at a time so that any colour variations between cubes are blended in.

Cut pavers to fill gaps along edges and around obstacles as required using cantilever splitters or masonry saws. For curves, place pavers beyond the final edge, mark off the desired curve, and then using a masonry saw cut the pavers in place. Ensure that area is washed down after cutting as the residue can create stains.

6. Compaction and Finishing:

After all pavers are in position (or at the end of each day), sweep off the surface completely and then compact the pavers into the bedding sand using a 5000 lbf plate tamper. Spread dry jointing sand and sweep into joints until full. Clean off surface and vibrate the jointing sand into spaces using the tamper. Repeat until joints are completely full.

For more advanced installation details, please visit: www.brownsconcrete.com

RETAINING WALL INSTALLATION

1. Planning

The height and purpose of the wall, as well as the existing soil types, groundwater conditions, and surrounding land uses, all play a part in the design of a retaining wall. That is why we recommend that you consult with your local supplier to verify which wall system will work for your given project.

Remember to incorporate a drainage system into your design so that water does not become trapped behind your wall.

2. Excavation & Base Preparation

Mark off the front and back of the wall, and then the front and back of the excavation; off-set at the front of the wall is typically 100-150mm (4-6") while the offset at the back of the wall is 150mm (6") for low walls (<27") and 300mm (12") for higher walls.

Where the excavation is cutting into a slope, grade the back of the excavation at the angle at which the native soil can be safely left without collapsing. To prevent the wall from sliding forward, it is common practice to bury at a minimum 1 full course of wall stones. The depth of the excavation also needs to allow for a 150mm (6") thick layer of base material.

Once the excavation is completed, remove any debris and then thoroughly compact the native soil.

Spread the backfill material in loose layers of no greater than 75mm (3"), wet the soil with water (helps increase compaction) and compact into place. Leave a V-notch at the back of the excavation for the drain pipe. Set string level to verify final grade. Ensure base is level front to back and side to side as this will minimize the leveling of individual blocks and will ensure straight lines and smooth arcs. Lay the geotextile starting just under the back of the wall and up the back slope of the trench.

Remember to leave adequate material at the top of the slope for the fold back, and to overlap the separate pieces a minimum of 150mm (6"). Use the sand bags or similar to keep the geotextile in place as required.

3. Laying the Base Course

Select the starting point for the wall. If the base of the wall is stepped up, start at the lowest point and work up; remember to adjust for the natural batter in the wall between steps. If there is an outside corner, start with the corner unit (to potentially avoid having to cut stones later on to fit). Set a string level to mark the back of the first course. Use a level to ensure the blocks are level front to back and side to side.

4. Remaining Courses

Sweep the top course prior to proceeding. Place the next course of units in a running bond pattern so that the middle of the unit is approximately above the joint between the underlying blocks. NEVER ALIGN BLOCKS VERTICALLY. After laying a course, backfill behind wall to the same elevation as the top of the just placed units.

5. Coping and Grading

Where coping is required, sweep the top of the underlying course prior to proceeding. Place a line of landscape adhesive on both sides of the tongue. Place the coping unit on top and apply some pressure to secure. Prior to back-filling behind the coping and last wall unit, pull filter cloth towards back of wall and tuck in place. Fill to final grade to suit to suit desired conditions; ensure final slopes allow for proper drainage away from the wall.

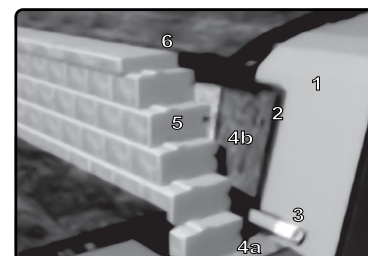

A large grid of graph paper, consisting of 20 columns and 30 rows of small squares, intended for project planning.



3075 Herold Drive Sudbury, ON P3E 6K9

Phone: 705.522.8220

Toll Free: 800.461.4888

Fax: 705.522.2732



CONCRETE
MASONRY &
HARDSCAPES
ASSOCIATION



CANADIAN
HOME BUILDERS'
ASSOCIATION

HORTICULTURAL TRADES ASSOCIATION
landscapeontario.com



Canadian Concrete Masonry
Producers Association
Region 4 of the National
Concrete Masonry
Association

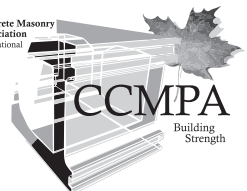

Authorized Dealer

All product measurements provided represent nominal dimensions. Product style, texture, and manufacturing process will dictate the tolerance that is considered normal and acceptable for that product type. Please refer to www.brownsconcrete.com for manufacturing tolerances.

www.brownsconcrete.com